

1-Phase PV Grid-Connected Inverter  
User Manual

**SG2K-S / SG2K5-S / SG3K-S /  
SG3K-D / SG5K-D / SG8K-D**





## **All Rights Reserved**

No part of this document can be reproduced in any form or by any means without the prior written permission of Sungrow Power Supply Co., Ltd (hereinafter “SUNGROW”).

## **Trademarks**

**SUNGROW** and other Sungrow trademarks used in this manual are owned by Sungrow Power Supply Co., Ltd.

All other trademarks or registered trademarks mentioned in this document are owned by their respective owners.

## **Software Licenses**

It is prohibited to use data contained in firmware or software developed by SUNGROW, in part or in full, for commercial purposes by any means.

It is prohibited to perform reverse engineering, cracking, or any other operations that compromise the original program design of the software developed by SUNGROW.

Sungrow Power Supply Co., Ltd.

Address: No.1699 Xiyou Rd., New & High Tech Zone, Hefei, 230088, China.

Email: [info@sungrow.cn](mailto:info@sungrow.cn)

Tel: +86 551 6532 7834

Website: [www.sungrowpower.com](http://www.sungrowpower.com)

# About This Manual

The manual mainly describes the product information, guidelines for installation, operation and maintenance. The manual cannot include complete information about the photovoltaic (PV) system. The reader can get additional information about other devices at [www.sungrowpower.com](http://www.sungrowpower.com) or on the webpage of the respective component manufacturer.

## Validity

This manual is valid for the following inverter models:

- SG2K-S
- SG2K5-S
- SG3K-S
- SG3K-D
- SG5K-D
- SG8K-D

They will be referred to as “inverter” hereinafter unless otherwise specified.

## Target Group

This manual is intended for:

- qualified personnel who are responsible for the installation and commissioning of the inverter; and
- inverter owners who will have the ability to interact with the inverter.





## How to Use This Manual

Read the manual and other related documents before any work on the inverter is carried out. Documents must be stored carefully and be available at all times.

Contents may be periodically updated or revised due to product development. The information in this manual is subject to change without notice. The latest manual can be acquired at [www.sungrowpower.com](http://www.sungrowpower.com).

## Symbols

Safety instructions will be highlighted with the following symbols.

Symbol	Explanation
	Indicates a hazard with a high level of risk that, if not avoided, will result in death or serious injury.
	Indicates a hazard with a medium level of risk that, if not avoided, could result in death or serious injury.
	Indicates a hazard with a low level of risk that, if not avoided, could result in minor or moderate injury.
NOTICE	Indicates a situation that, if not avoided, could result in equipment or property damage.
	Indicates additional information, emphasized contents or tips that may be helpful, e.g. to help you solve problems or save time.

# Contents

---

<b>About This Manual .....</b>	<b>II</b>
<b>1 Safety .....</b>	<b>1</b>
1.1 PV Panels .....	1
1.2 Utility Grid .....	1
1.3 Inverter.....	2
1.4 Skills of Qualified Personnel .....	3
<b>2 Product Description .....</b>	<b>4</b>
2.1 Intended Use .....	4
2.2 Product Introduction.....	5
2.2.1 Model Description .....	5
2.2.2 Appearance .....	5
2.2.3 Dimensions .....	7
2.2.4 LCD Panel.....	7
2.3 Function Description .....	8
2.3.1 Basic Function.....	8
2.3.2 External Demand Response (“AU”/“NZ”).....	8
2.3.3 Reactive Power Regulation .....	9
2.3.4 Power Quality Response.....	9
<b>3 Unpacking and Storage .....</b>	<b>10</b>
3.1 Unpacking and Inspection.....	10
3.2 Identifying the Inverter .....	10
3.3 Scope of Delivery.....	12
3.4 Inverter Storage .....	13
<b>4 Mechanical Mounting.....</b>	<b>14</b>
4.1 Safety during Mounting .....	14
4.2 Location Requirements .....	14
4.2.1 Installation Environment Requirements .....	15
4.2.2 Carrier Requirements .....	15

4.2.3	Installation Angle Requirements .....	15
4.2.4	Installation Clearance Requirements .....	16
4.3	Installation Tools .....	16
4.4	Moving the Inverter .....	18
4.5	Installing the Inverter .....	19
<b>5</b>	<b>Electrical Connection .....</b>	<b>21</b>
5.1	Safety Instructions .....	21
5.2	Terminal Description .....	22
5.3	Cable Requirements .....	23
5.4	Additional Grounding Connection .....	23
5.4.1	Additional Grounding Requirements .....	23
5.4.2	Connection Procedure .....	24
5.5	AC Cable Connection .....	24
5.5.1	AC Side Requirements .....	25
5.5.2	Assembling the AC Connector .....	26
5.5.3	Installing the AC Connector .....	27
5.6	DC Cable Connection .....	27
5.6.1	PV Input Configuration .....	28
5.6.2	Assembling the PV Connector .....	31
5.6.3	Installing the PV Connector .....	32
5.7	RS485 Communication Connection .....	33
5.8	Energy Meter Connection .....	33
5.9	DRM Connection ("AU"/"NZ") .....	35
<b>6</b>	<b>Commissioning .....</b>	<b>38</b>
6.1	Inspection before Commissioning .....	38
6.2	Button Function .....	38
6.3	Commissioning Procedure .....	38
<b>7</b>	<b>LCD Operation .....</b>	<b>40</b>
7.1	Button Function .....	40
7.2	Main Screen .....	40
7.3	Menu Structure .....	42
7.4	Viewing Running Info .....	43

7.5	Advanced Settings .....	43
7.5.1	Inputting the Password .....	43
7.5.2	Setting Protective Parameters .....	44
7.5.3	Zero-export Setting .....	47
7.5.4	Adding the Existing Inverter .....	48
7.5.5	PF Setting .....	48
7.5.6	Parameter Reset .....	48
7.5.7	DRM Switch Setting ("AU"/"NZ") .....	48
7.5.8	GND Detection .....	49
7.5.9	Energy Adjustment .....	49
7.5.10	Setting Communication Parameter .....	49
7.5.11	Ethernet Configuration .....	49
7.5.12	Arc Detection .....	50
7.6	Starting/Stopping the Inverter .....	50
7.7	Viewing the Error Record .....	50
7.8	Setting the Time .....	50
7.9	Setting the Country .....	51
7.10	Viewing Device Info .....	53
<b>8</b>	<b>System Decommissioning .....</b>	<b>54</b>
8.1	Disconnecting the Inverter .....	54
8.2	Dismantling the Inverter .....	55
8.3	Disposing of the Inverter .....	55
<b>9</b>	<b>Troubleshooting and Maintenance .....</b>	<b>56</b>
9.1	Troubleshooting .....	56
9.1.1	LED Indicator .....	56
9.1.2	Errors on the App or LCD Screen .....	56
9.2	Maintenance .....	62
<b>10</b>	<b>Appendix .....</b>	<b>64</b>
10.1	Technical Data .....	64
10.1.1	-S Series .....	64
10.1.2	-D Series .....	65
10.2	Quality Assurance .....	67



# 1 Safety

The inverter has been designed and tested strictly according to international safety regulations. Read all safety instructions carefully prior to any work and observe them at all times when working on or with the inverter.

Incorrect operation or work may cause:

- injury or death to the operator or a third party; or
- damage to the inverter and other properties.

All detailed work-related safety warnings and notes will be specified at critical points in this manual.



- The safety instructions in this manual cannot cover all the precautions that should be followed. Perform operations considering actual onsite conditions.
- SUNGROW shall not be held liable for any damage caused by violation of the safety instructions in this manual.

## 1.1 PV Panels

### DANGER

**PV strings will produce electrical power when exposed to sunlight and can cause a lethal voltage and an electric shock.**

- **Always keep in mind that the inverter is dual power supplied. Electrical operators must wear proper personal protective equipment: helmet, insulated footwear, gloves, etc.**
- **Before touching the DC cables, operator must use a measuring device to ensure that the cable is voltage-free.**
- **The operator must follow all warnings on the PV strings and in its manual.**

## 1.2 Utility Grid

Follow the regulations related to the utility grid.

**NOTICE**

All electrical connections must be in accordance with local and national standards.

Only with the permission of the local utility grid company, the inverter can be connected to the utility grid.

## 1.3 Inverter

** DANGER**

Danger to life from electric shocks due to live voltage

Do not open the enclosure at any time. Unauthorized opening will void warranty and warranty claims and in most cases terminate the operating license.

** WARNING**

Risk of inverter damage or personal injury

- Do not disconnect the PV connectors and AC connector when the inverter is running.
- Disconnect the AC circuit breaker and set the DC load-break switch of the inverter to OFF. Wait at least 10 minutes for the internal capacitors to discharge.
- Ensure that there is no voltage or current before disconnecting any connectors.

** WARNING**

All safety instructions, warning labels, and nameplate on the inverter:

- Must be clearly legible.
- Should not be removed or covered.

** CAUTION**

Risk of burns due to hot components!

Do not touch any hot parts (such as the heat sink) during operation. Only the buttons and the DC switch can safely be touched at any time.

**NOTICE**





**Only qualified personnel can perform the country setting. Unauthorized alteration may cause a breach of the type-certificate marking.**

**Risk of inverter damage due to electrostatic discharge (ESD)!**

**By touching the electronic components, you may damage the inverter. For inverter handling, be sure to:**

- **avoid any unnecessary touching;**
- **wear a grounding wristband before touching any connectors.**

**Warning Label**

Label	Description
	Disconnect the inverter from all the external power sources before maintenance!
	Do not touch live parts for 10 minutes after disconnection from the power sources.
	Burn danger due to hot surface that may exceed 60 °C.
	Danger to life due to high voltages! Only qualified personnel can open and maintain the inverter.
	Read the user manual before maintenance!

**1.4 Skills of Qualified Personnel**

All installations must be performed by qualified personnel who should have:

- Training for installation and commissioning of electrical system, as well as dealing with hazards
- knowledge of the manual and other related documents
- knowledge of the local regulations and directives

# 2 Product Description

## 2.1 Intended Use

SG2K-S / SG2K5-S / SG3K-S / SG3K-D / SG5K-D / SG8K-D, a transformerless single-phase PV grid-connected inverter, is an integral component in the PV power system.

The inverter is designed to convert the direct current power generated from the PV modules into grid-compatible AC current and feeds the AC current to the utility grid.

### WARNING

**The inverter must only be operated with PV strings with class II protection in accordance with IEC 61730, application class A. It is not allowed for the positive pole or the negative pole of the PV strings to be grounded. This can cause the inverter to be destroyed.**

**Damages to the product due to a faulty or damaged PV installation are not covered by warranty.**

**Any use other than the one described in this document is not permitted.**

The intended use example is shown in **Fig. 2-1**.

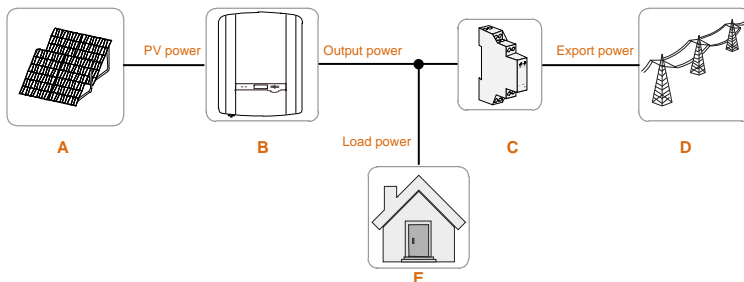

**Fig. 2-1** Application in a PV Power System

Item	Description	Remarks
A	PV strings	Compatible with monocrystalline silicon, polycrystalline silicon and thin-film without grounding.

Item	Description	Remarks
B	Inverter	SG2K-S, SG2K5-S, SG3K-S, SG3K-D, SG5K-D and SG8K-D.
C	Single-phase energy meter (optional)	Measures the export power and communicates with the inverter via an RS485 connection.
D	Utility grid	Grid earthing system types: TT, TN.
E	Household load	Devices that consume energy.

## NOTICE

**For the TT utility grid, the N line voltage to ground must be 30 V or less.**

## 2.2 Product Introduction

### 2.2.1 Model Description

The model description is as follows (Take SG3K-S as an example):

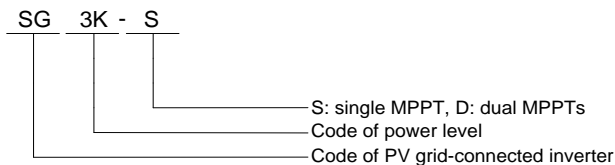

**Tab. 2-1** Power Level Description

Model	Nominal Output Power	Nominal Grid Voltage
SG2K-S	2000 W	230 Vac (single phase)
SG2K5-S	2500 W	
SG3K-S	3000 W	
SG3K-D	3000 W	
SG5K-D	4990 W	
SG8K-D	8000 W	

### 2.2.2 Appearance

The image shown here is for reference only. The actual product you receive may differ.

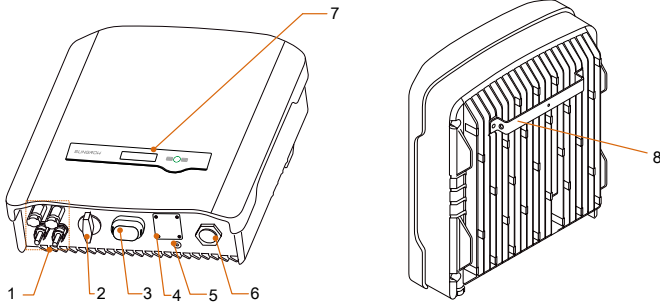

**Fig. 2-2** Inverter Appearance (SG5K-D for reference)

Item	Name	Description
1	PV terminals	Positive and negative DC input connectors. One or two or three pairs, depending on inverter model.
2	DC switch	To disconnect the DC current safely.
3	RS485 terminal	To connect the communication module, such as Wi-Fi module.
4	Meter   DRM terminal	Connections to the energy meter and external Demand Response Enabling Device (DRED).
5	Additional grounding terminal	For reliable grounding.
6	AC terminal	To feed power into the utility grid.
7	LCD panel	The display and two buttons can be used to access current operating data or change inverter settings.
8	Mounting rack	For mounting the inverter to the wall mounting bracket.

### 2.2.3 Dimensions

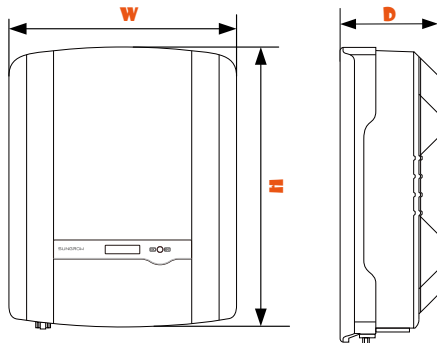

Fig. 2-3 Dimensions of the Inverter

#### Dimensions and Weight

Model	W (mm)	H (mm)	D (mm)
SG2K-S / SG2K5-S / SG3K-S	300	370	125
SG3K-D / SG5K-D	360	390	133
SG8K-D	360	390	148

### 2.2.4 LCD Panel

The LCD panel with a screen, an indicator and two buttons is on the front of the inverter.

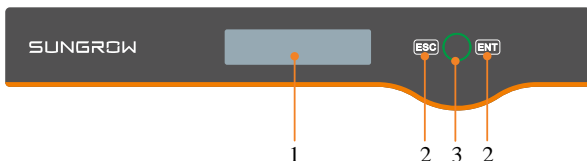

Fig. 2-4 LCD Panel

No.	Name	Description
1	LCD screen	Display and access current operating data or change inverter settings.
2	Buttons	ESC / ENT. View or set parameters via the buttons. For detailed functions, see <b>Tab. 6-1</b> .
3	Indicator	Green / red. User can observe the color and blinking frequency to get the current state of the inverter. For detailed definition, see <b>Tab. 6-2</b> .

## 2.3 Function Description

### 2.3.1 Basic Function

- Conversion function

The inverter converts DC power from the PV array into grid-compliant AC power and feeds it into the utility grid.

- Data storage

The inverter logs essential data including running information and error records.

- Parameter configuration

The inverter provides various parameter configurations for optimal operation. You can set the country via the iSolarCloud App or the cloud server, in case you require further configuration, please contact Sungrow.

- Communication interface

You can choose the RS485 terminal for connecting a communication module to the PV system, such as Wi-Fi module.



- It is recommended to use the communication module from Sungrow. Using a device from other companies may lead to communication failure or other unexpected damage.
- Further information on the communication module can be found in the respective Quick Installation Guide.

- Earth fault alarm

If an earth fault occurs, the error code will be displayed on the LCD screen. The buzzer inside the inverter will beep to signal an external alarm.

- Protective function

Several protective functions are integrated in the inverter, including short circuit protection, grounding insulation resistance surveillance, residual current protection, anti-islanding protection, DC overvoltage/ over-current protection, etc.

### 2.3.2 External Demand Response (“AU”/“NZ”)

The inverter provides a RJ45 port for connecting to a demand response enabling device (DRED). The DRED asserts demand response modes (DRMs). The inverter detects and initiates a response to the supported demand response commands within 2s. The following table lists the DRMs supported by the inverter.



**Tab. 2-2** Demand Response Modes (DRMs)

Mode	Explanation
DRM0	The inverter is in the state of standby.
DRM5	The export power to the grid is 0.
DRM6	The export power to the grid is no more than 50 % of the rated power.
DRM7	The export power to the grid is no more than 75 % of the rated power.
DRM8	The export power to the grid is 100 % of the rated power, but subject to the constraints from other active DRMs.

### 2.3.3 Reactive Power Regulation

The inverter is capable of operating in reactive power regulation modes for the purpose of providing support to the grid. These various operating modes can be enabled or disabled via the LCD menu.

- **PF**: Fixed power factor mode.
- **Qt**: Fixed reactive power mode.
- **Q(p)**: The PF of the inverter output varies in response to the output power of the inverter.
- **Q(u)**: The reactive power output of the inverter varies in response to the grid voltage. (Not applicable for “TH” 230 V grid)

### 2.3.4 Power Quality Response

The inverter supports two power quality response modes.

- Power response for voltage variations (only for “AU”/“NZ”)

Define the response curve with four reference voltages, which can be set via the LCD menu. The power output will vary in response to the voltage curve. Refer to “**7.5.2 Setting Protective Parameters**” for details.

- Power response for frequency variations

The inverter provides built-in over- / under-frequency protective threshold values. Refer to “**Tab. 7-9 Protective Parameters of Grid Standards**” for details. When the grid frequency is lower than the under-frequency limit or higher than the over-frequency limit, the inverter will be disconnected from the grid.

When there is an increase in grid frequency which exceeds the start value, the inverter will reduce the power output linearly with an increase of frequency until the end value is reached. (Not applicable for “TH” 220 V grid)

## **3 Unpacking and Storage**

### **3.1 Unpacking and Inspection**

The inverter is thoroughly tested and strictly inspected before delivery. Damage may still occur during shipping. For this reason, please conduct a thorough inspection after receiving the device.

1. Check the packing case for any visible damage.
2. Check the scope of delivery for completeness according to the packing list.
3. Check the inner contents for damage after unpacking.

Contact SUNGROW or the supplier in case of any damage or incompleteness.

Do not dispose of the original packing case. It is recommended to store the inverter in it.

### **3.2 Identifying the Inverter**

The nameplate can be found on both the inverter and the packing case. It provides information on the model of inverter, important specifications, marks of certification institutions, and serial number which are available and identified by SUNGROW. Take SG5K-D as an example:

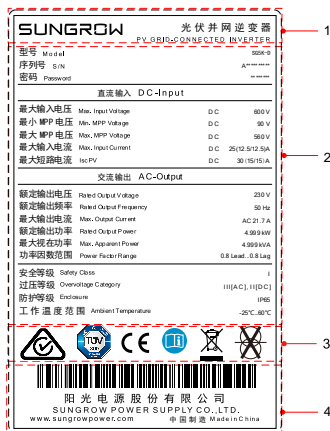

Fig. 3-1 Nameplate of Inverter

\* The image shown here is for reference only. The actual product you receive may differ.

Item	Description	Item	Description
1	SUNGROW logo and product model	3	Instructions and marks of conformity
2	Technical data of inverter	4	Company name, website and country of manufacture

Tab. 3-1 Description of Icons on the Nameplate

Icon	Description
	RCM mark of conformity.
	Do not dispose of the inverter together with household waste.
	The inverter does not have a transformer.
	Refer to the corresponding instructions.
	TÜV mark of conformity.
	CE mark of conformity.

## 3.3 Scope of Delivery

### Standard Delivery

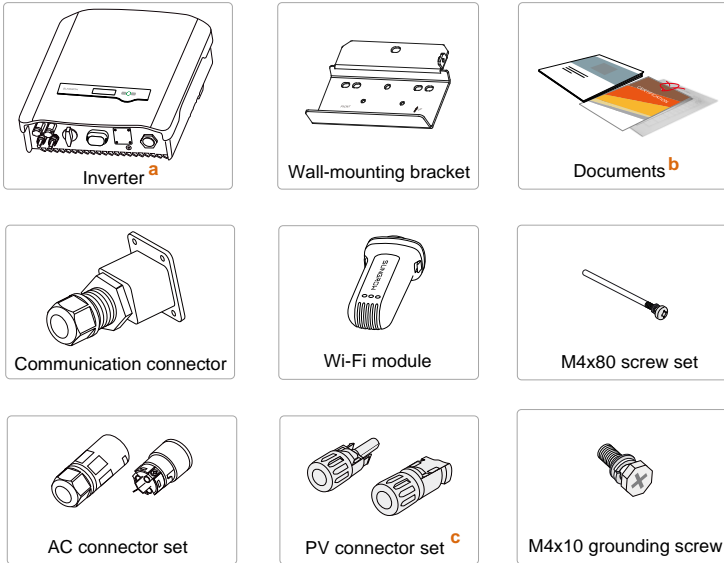

**Fig. 3-2** Delivery Contents

- The inverter figures in this document have been created for SG5K-D unless otherwise specified.
- The documents include the Quick User Manual, quality certificates, packaging list and product test reports.
- One or two or three pairs, depending on inverter model.

### Optional Accessory

The Energy Meter is not included in the inverter packaging but, if ordered, delivered separately.

More detailed information on the Energy Meter can be found in the respective Quick Installation Guide.

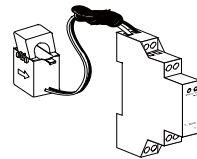

Single-phase meter

### 3.4 Inverter Storage

Proper storage is required if the inverter is not installed immediately.

- Store the inverter in the original packing case with the desiccant inside.
- The storage temperature should be always between  $-30^{\circ}\text{C}$  and  $+85^{\circ}\text{C}$ , and the storage relative humidity should be always between 0 and 100 %, non-condensing.
- In case of stacking storage, the number of stacking layers should never exceed the limit marked on the outer side of the packing case.

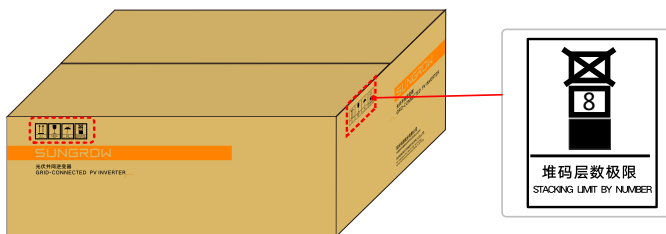

- The packaging should be upright.
- If the inverter has been stored more than half a year, the qualified personnel should thoroughly check and test it before installation.

## 4 Mechanical Mounting

### 4.1 Safety during Mounting

#### DANGER

Make sure there is no electrical connection before installation.

In order to avoid electric shock or other injury, make sure that holes will not be drilled over any electricity or plumbing installations.

#### CAUTION

Risk of injury due to improper handling

- Always follow the instructions when moving and positioning the inverter.
- Improper operation may cause injuries or serious wounds.
- In the case of poor ventilation, the system performance may compromise.
- Keep the heat sinks uncovered to ensure heat dissipation performance.

#### NOTICE

Wear gloves to avoid scratches when mounting the inverter.

### 4.2 Location Requirements

Select an optimal mounting location for safe operation, long service life and expected performance.

The inverter with IP65 can be installed both indoors and outdoors.

Install the inverter in a place convenient for electrical connection, operation and maintenance.

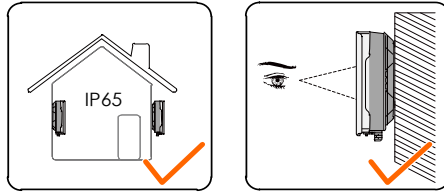

### 4.2.1 Installation Environment Requirements

- The installation environment must be free of inflammable or explosive materials.
- The location should be not accessible to children.
- The ambient temperature and relative humidity must meet the following requirements.

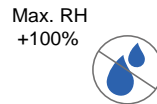
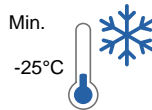

- Avoid direct exposure to sun, rain and snow.
- The inverter should be well ventilated. Ensure air circulation.
- Never install the inverter in living areas. The inverter will generate noise during operation, affecting daily life.

### 4.2.2 Carrier Requirements

The installation carrier should meet the following requirements:



Made of non-flammable materials



Max. load bearing capacity  $\geq 4$  times of the inverter weight

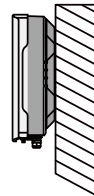

### 4.2.3 Installation Angle Requirements

Never install the inverter horizontally, or with a forward tilt or with a backward tilt or even upside down. The horizontal installation can result in damage to the inverter.

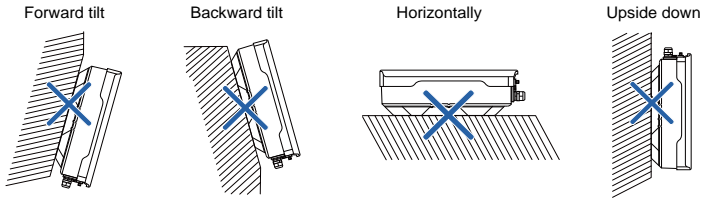

### 4.2.4 Installation Clearance Requirements

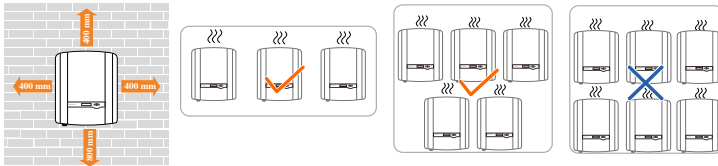

Reserve enough clearance around the inverter to ensure sufficient space for heat dissipation. Clearance requirement and multiple installation:



For multi-row installation, the distance between two adjacent rows should be at least 400 mm.

### 4.3 Installation Tools

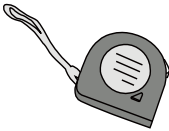
Installation tools include but are not limited to the following recommended ones. If necessary, use other auxiliary tools on site.

General tools (recommended)		
Marker 	Measuring tape 	Level 

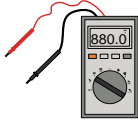
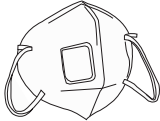
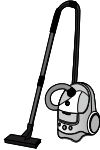
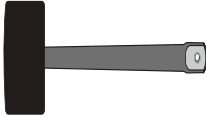

<p>Utility knife</p> 	<p>Multimeter Measurement range: <math>\geq</math> 1100Vdc</p> 	<p>Wrist strap</p> 
<p>Protective gloves</p> 	<p>Dust mask</p> 	<p>Earplugs</p> 
<p>Goggles</p> 	<p>Insulated shoes</p> 	<p>Vacuum cleaner</p> 
<p>Heat shrink tubing</p> 	<p>-</p>	<p>-</p>
<p><b>Installation tools (recommended)</b></p>		
<p>Heat gun</p> 	<p>Hammer drill Drill bit: <math>\varphi 10</math></p> 	<p>Rubber mallet</p> 

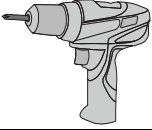
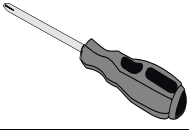
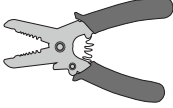
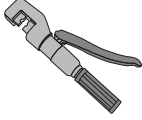
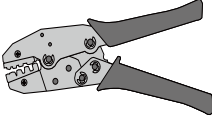
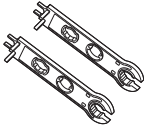
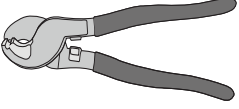
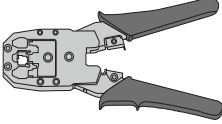
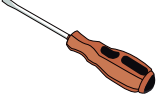
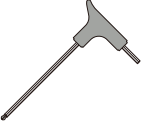
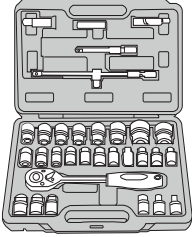
<p>Electric screwdriver Tool bit: M4, M6</p> 	<p>Phillips screwdriver Specification: M4, M6</p> 	<p>Wire stripper</p> 
<p>Hydraulic plier</p> 	<p>Crimping tool Crimping range: 4-6 mm<sup>2</sup></p> 	<p>Wrench for MC4 terminal</p> 
<p>Wire clipper</p> 	<p>RJ45 crimping tool</p> 	<p>Flat-blade screwdriver M4</p> 
<p>Torx screwdriver TX30</p> 	<p>Socket wrench Open end: 10 mm (for M6 bolts) 13 mm (for M8 bolts) 16 mm (for M10 bolts)</p>	

## 4.4 Moving the Inverter

Before installation, remove the inverter from the packing case and move it to the installation site. Follow the instructions below as you move the inverter:

- Always be aware of the weight of the inverter.
- Lift the inverter using the handles positioned on both sides of the inverter.
- Move the inverter by at least two people or by using a proper transport tool.
- Do not release the equipment unless it has been firmly secured.

## 4.5 Installing the Inverter

Inverter is installed on the wall by means of wall-mounting bracket and the expansion plug sets.

The expansion plug set shown below is recommended for the installation. They are not included in the delivery scope.

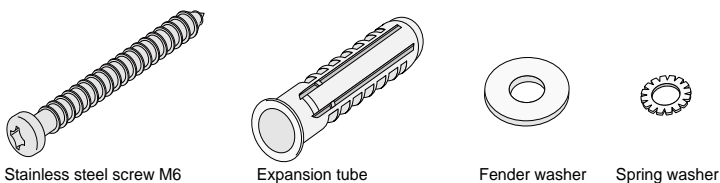

1. Align the wall mounting bracket horizontally on the wall with the arrow upwards. Mark the position of the drill holes. Use at least one hole on the right- and left-hand side of the wall mounting bracket.

Tip: When mounting on a post, use the upper and lower central holes of the wall mounting bracket.

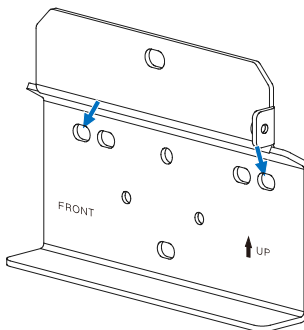

2. Set the wall mounting bracket aside and drill the marked holes. The depth of the holes should be about 70 mm. Install the wall-mounting bracket with a torque of 9.0 N·m.



3. Mount the inverter to the bracket, and secure it with an M4x80 screw (torque: 1.5 N·m).

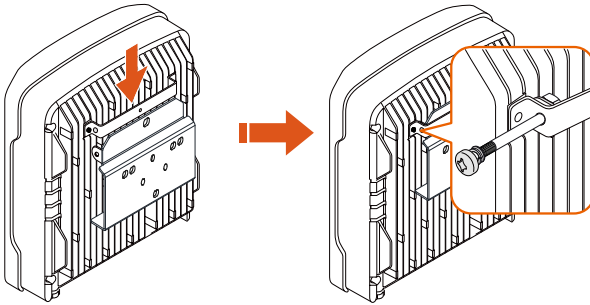

4. To protect the inverter from theft, you can lock it with a padlock. The padlock is purchased by the user if necessary. The hole diameter is about 8 mm.

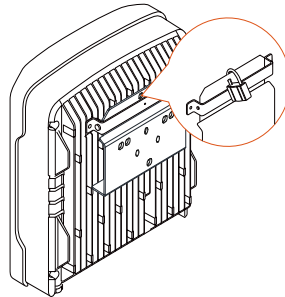

5. Remove the waterproof lid from RS485 terminal and install the communication module to the inverter. The following figure takes the Wi-Fi module as an example. Refer to the manual delivered with the module for details.

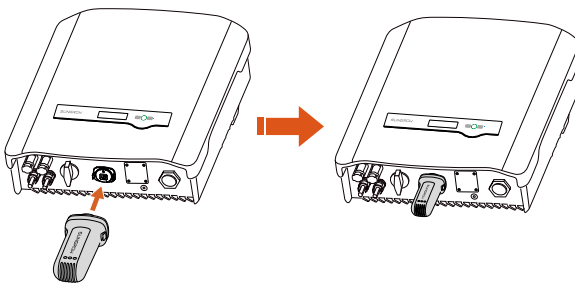

# 5 Electrical Connection

## 5.1 Safety Instructions

Prior to any electrical connections, keep in mind that the inverter has dual power supplies. It is mandatory for the technical personnel to wear personal protective equipments (PPE) during the electrical work.

### DANGER

**Danger to life due to a high voltage inside the inverter**

- **The PV string will generate lethal high voltage when exposed to sunlight.**
- **Before starting electrical connections, disconnect the DC and AC circuit breakers and prevent them from inadvertent reconnection.**
- **Ensure that all cables are voltage free before performing cable connection.**

### WARNING

**Any improper operations during cable connection can cause device damage or personal injury.**

**Only qualified personnel can perform cable connection.**

**All cables must be undamaged, firmly attached, properly insulated and adequately dimensioned.**

### NOTICE

**Comply with the safety instructions related to the PV strings and the regulations related to the utility grid.**

**All electrical connections must be in accordance with local and national standards.**

**Only with the permission of the local utility grid company, the inverter can be connected to the utility grid.**

## 5.2 Terminal Description

All electrical terminals are located at the bottom of the inverter.

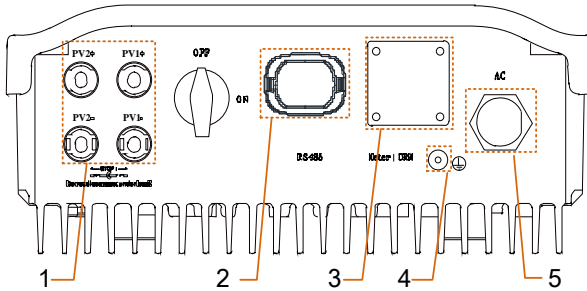

Fig. 5-1 Terminal Description

\* Image shown here is for reference only. The actual product you receive may differ.

Tab. 5-1 Terminal Descriptions

No.	Terminal	Description	Decisive Voltage Classification
1	PV terminals	MC4 terminals for PV inputs. -S series: one pair of PV terminals. -D series: three pairs for SG8K-D and two pairs for other -D inverters.	DVC-C
2	RS485 terminal	To connect the WiFi module.	DVC-A
3	Meter   DRM terminal	The left hole is for meter communication and the right is for DRED communication.	DVC-A
4	Additional grounding terminal	For reliable grounding.	Not applicable
5	AC terminal	AC terminal for connection to the utility grid.	DVC-C

## 5.3 Cable Requirements

No.	Cable	Inverter Model	Specification	
			Outer diameter (mm)	Conductor Cross-section (mm <sup>2</sup> )
1	AC cable <sup>(1)</sup>	SG2K-S / SG2K5-S / SG3K-S / SG3K-D / SG5K-D	10–14	4–6
2	PV cable <sup>(2)</sup>	All	6–9	4–6
3	Additional grounding cable	All	/	4–6

1. The AC cable must be dimensioned in accordance with the local and national directives for the dimensioning of cables.
2. The PV cables must be multi-core cables, of which the maximum withstand voltage is 600 V and the maximum withstand current is the same as the short-circuit current.

## 5.4 Additional Grounding Connection

### WARNING

- **Since the inverter is transformerless, neither the negative pole nor the positive pole of the PV string must be grounded. Otherwise, the inverter will not operate normally.**
- **Connect the additional grounding terminal to the protective grounding point before AC cable connection, PV cable connection, and communication cable connection.**
- **The ground connection of this additional grounding terminal cannot replace the connection of the PE terminal of the AC cable. Make sure the two terminals are both grounded reliably.**

### 5.4.1 Additional Grounding Requirements

All non-current carrying exposed metal parts of the equipment and other enclosures in the PV power system should be grounded, e.g. PV strings frame and inverter enclosure.

The additional grounding terminal is equipped at the bottom of the inverter. Be sure to connect this additional grounding terminal for reliable grounding and ensure that the grounding resistance is less than 10 Ohm.

## 5.4.2 Connection Procedure

The additional grounding cable should be of the same cross section as the PE wire in the AC cable.

Additional grounding cable and OT/DT terminal are prepared by customers.

1. Prepare the cable and OT/DT terminal.

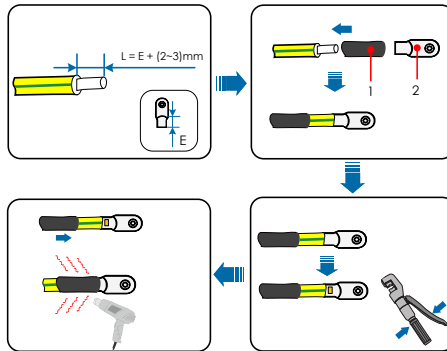

1: Heat shrink tubing

2: OT/DT terminal

2. Fasten the cable to the grounding terminal with a screwdriver.

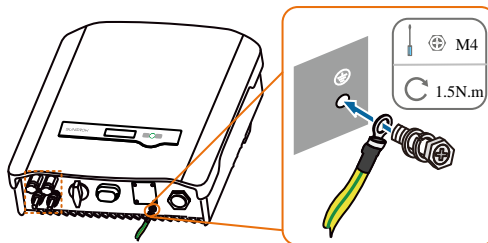

3. Apply paint to the grounding terminal to ensure corrosion resistance.

## 5.5 AC Cable Connection

The inverter is connected to the grid via 3 wires (L, N and PE).

Inverter is equipped with the waterproof direct plug-in connector which matches the AC terminal at the bottom of the inverter.



### 5.5.1 AC Side Requirements



Connect the inverter to the grid only after getting an approval from the local electric power company.

Before connecting the inverter to the grid, ensure the grid voltage and frequency comply with requirements, for which, refer to "**10.1 Technical Data**". Otherwise, contact the utility grid company for help.

#### AC Circuit Breaker

An independent two-pole circuit breaker must be installed on the output side of the inverter to ensure safe disconnection from the grid. The recommended specifications are as follows:

Inverter Model	Specification
SG2K-S / SG2K5-S	15 A
SG3K-S / SG3K-D	20 A
SG5K-D	32 A
SG8K-D	50 A

#### NOTICE

**Multiple inverters cannot share one circuit breaker.**

**Never connect a load between the inverter and the circuit breaker.**

#### Residual Current Device

With an integrated universal current-sensitive residual current monitoring unit included, the inverter will disconnect immediately from the mains power once a fault current with a value exceeding the limit has been detected.

However, if an external residual current device (RCD) is mandatory, the switch must be triggered at a residual current of 300 mA (recommended), or it can be set to other values according to local regulations. For example in Australia, the inverter can use an additional 30 mA (type A) RCD in installations.

## 5.5.2 Assembling the AC Connector

1. Lead the AC cable through the swivel nut and the housing.
2. Remove the cable jacket by 40 mm, and strip the wire insulation by 8-15 mm.

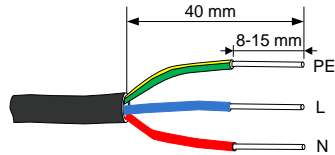
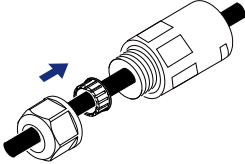

3. Fully insert the conductors to the corresponding terminal and tighten the screws with a torque of 0.8 N·m. Pull cables outward to check whether they are firmly installed.

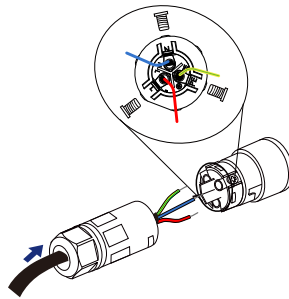

### NOTICE

**Observe the terminal layout on the block. Avoid connecting the phase wires to "PE" terminal or PE wire to "N" terminal, and otherwise, unrecoverable damage to the inverter may follow.**

4. Assemble the housing, the terminal block and the swivel nut (torque 4–5 N·m for SG8K-D and 2–3 N·m for other models). Make sure that the rib of the terminal block and the groove on the housing engage perfectly until a "Click" is heard or felt.

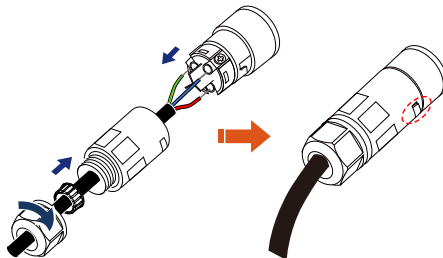

### 5.5.3 Installing the AC Connector

1. Disconnect the AC circuit breaker and secure it against reconnection.
2. Measure the voltage and frequency of the grid-connected point to ensure that they are within the specified range listed in “10.1 Technical Data”.
3. Align the AC connector and the AC terminal and mate them together by hand. Tighten the connector to the terminal until a “Click” is heard or felt. (Hand-tight)

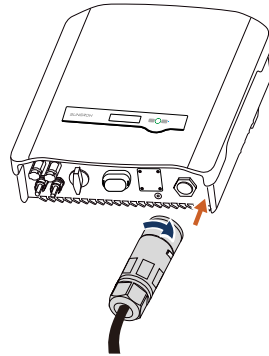

4. Connect the other ends. Connect “PE” conductor to the grounding electrode. Connect “L” and “N” conductors to the AC circuit breaker.

#### NOTICE

**The PE wire of the AC terminal must be directly connected to the grounding bar. Do not connect it to protection devices such as the circuit breaker.**

5. Pull all the lines outward to check whether they are firmly installed.

## 5.6 DC Cable Connection

### **⚠ DANGER**

**Danger of electric shock**

**The PV array will generate lethal high voltage once exposed to sunlight.**

### **⚠ WARNING**

**Make sure the PV array is well insulated to ground before connecting it to the inverter.**

**NOTICE**

**Risk of inverter damage! Observe the following requirements. Failure to do so will void guarantee and warranty claims.**

- **Make sure the maximum short circuit current on the DC side is within the permissible range.**
- **Make sure the maximum voltage of each string is always less than 600 V.**
- **The inverter enters the standby state when the input voltage ranges between 560 V and 600 V. The inverter returns to the running state once the voltage returns to the MPPT operating voltage range, namely, 90 V to 560 V.**

**5.6.1 PV Input Configuration**

**-S Series**

There is one input area with one MPP tracker. Only one input can be connected, as shown in the following figure.

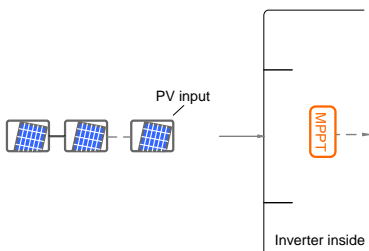

Model	Total PV Input Power Limit	Open-circuit Voltage Limit	Max. current for input connector
SG2K-S	3000 W	600 V	15 A
SG2K5-S	3200 W	600 V	15 A
SG3K-S	4000 W	600 V	15 A

**-D Series**

For -D inverters except SG8K-D, there are two pairs of PV terminals, each with its MPP tracker.

The inverter SG8K-D has three pairs of PV terminals. The PV1 has an independent MPP tracker. The PV2 has two pairs of PV terminals, which are internal paralleled and with one MPP tracker.

The PV1 and PV2 can be configured in independent mode or parallel mode.

**NOTICE**

**For SG8K-D, the PV strings to PV2 input should have the same PV module type, the same string length, identical tilt and identical orientation.**

- Independent Mode

Each PV input operates independently and has its own MPPT. In this way, string structures of each PV input may differ from each other, including PV module type, number of PV modules in each string, angle of tilt, and installation orientation.

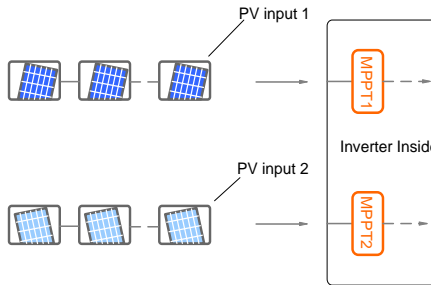

**Fig. 5-2** Independent Mode for -D inverters except SG8K-D

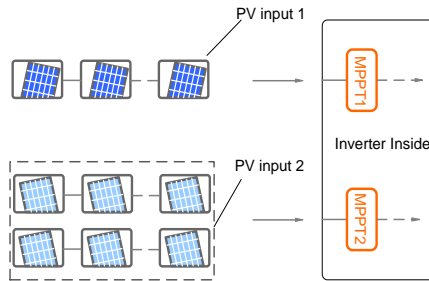

**Fig. 5-3** Independent Mode for SG8K-D



Only the current is limited for a single input and the power is not limited.

Prior to connecting the inverter to PV inputs, the specifications in the following table should be met:

Model	Total PV Input Power Limit	Open-circuit Voltage Limit (PV1/ PV2)	Max. current for input connector (PV1/ PV2)
SG3K-D	4000 W	600 V / 600 V	30 A (15 A / 15 A)

Model	Total PV Input Power Limit	Open-circuit Voltage Limit (PV1/ PV2)	Max. current for input connector (PV1/ PV2)
SG5K-D	6500 W	600 V / 600 V	30 A (15 A / 15 A)
SG8K-D	10400 W	600 V / 600 V / 600 V	15 A / 15 A / 15 A

• Parallel Mode

All PV strings should be the same in PV string structure, including the type, number, tilt, and orientation of the PV modules.

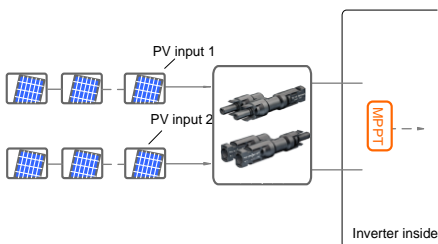

Fig. 5-4 Parallel Mode for -D inverters except SG8K-D

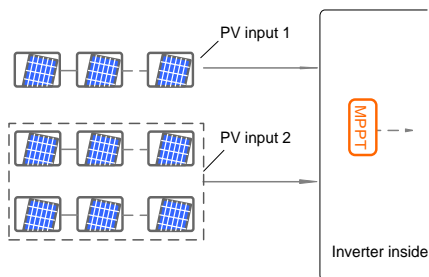

Fig. 5-5 Parallel Mode for SG8K-D

Prior to connecting the inverter to PV inputs, the specifications in the following table should be met:

Model	Total PV Input Power Limit	Open-circuit Voltage Limit	Max. current for input connector
SG3K-D	4000 W	600 V	30 A
SG5K-D	6500 W	600 V	30 A
SG8K-D	10400 W	600 V	45 A



To avoid the input power unbalance of the two inputs or input load-restriction, ensure the two PV input cables are of the same type.

## 5.6.2 Assembling the PV Connector

SUNGROW provides corresponding plug connectors in the scope of delivery for quick connection of PV inputs.

DC cables should be connected to the inverter via PV connectors which are included in the scope of delivery.



To ensure IP65 protection, use only the supplied connector or the connector with the same ingress of protection.

### DANGER

**High voltage may be present in the inverter!**

**Ensure all cables are voltage-free before performing electrical operations.**

**Do not connect the AC circuit breaker before finishing electrical connection.**

### NOTICE

**Use the MC4 DC terminal within the scope of delivery. Damage to the device due to the use of incompatible terminal shall not be covered by the warranty.**

Procedure:

- Strip the insulation from each DC cable by 7 mm.
- Assemble the cable ends with the crimping pliers.

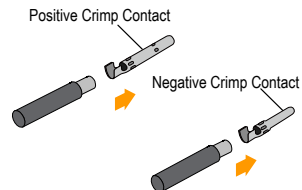
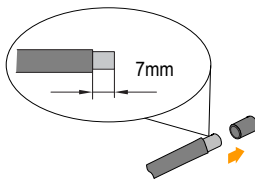

- Lead the cable through cable gland, and insert into the insulator until it snaps into place. Gently pull the cable backward to ensure firm connection. Tighten the cable gland and the insulator (torque 2.5 N·m to 3 N·m).

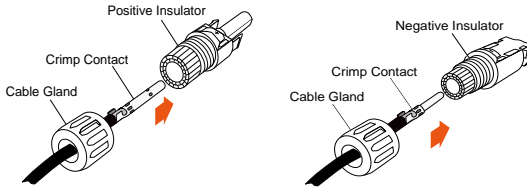

4. Check for polarity correctness.

## NOTICE

**The inverter will not function properly if any PV polarity is reversed.**

### 5.6.3 Installing the PV Connector

Connect the inverter to PV strings according to the following procedure.

1. Rotate the DC switch to “OFF” position.

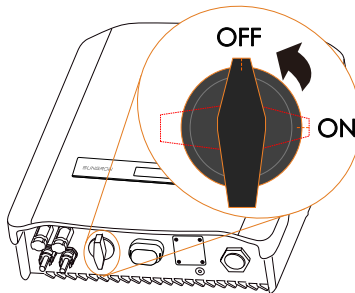

2. Check the cable connection of the PV string for polarity correctness and ensure that the open circuit voltage in any case does not exceed the inverter input limit of 600 V.

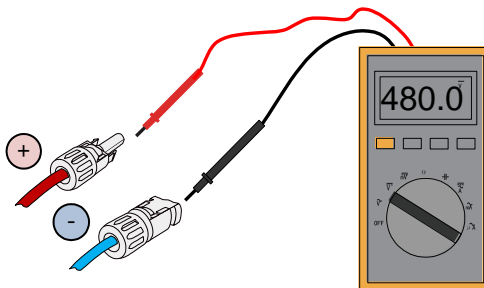



**NOTICE**

**Check the positive and negative polarity of the PV strings, and connect the PV connectors to corresponding terminals only after ensuring polarity correctness.**

**Electric arc or contactor over temperature may occur if the PV connectors are not firmly in place, and SUNGROW shall not be held liable for any damage caused due to this operation.**

3. Connect the PV connectors to corresponding terminals until there is an audible click.

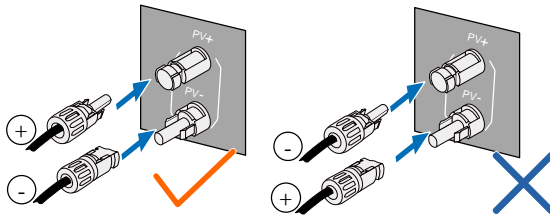

\* The image shown here is for reference only. The actual product you receive may differ.

4. (-D series) Seal the unused PV terminals with the terminal caps.

## 5.7 RS485 Communication Connection

For the WiFi installation, see the last step in section “4.5 Installing the Inverter”. More detailed information on the RS485 communication module can be found in the respective manual.

**NOTICE**

**The RS485 terminal can also be used to connect an external RS485 device. For the pin definition and waterproof procedure, please contact SUNGROW.**

**Failure to comply with the requirements of wiring or waterproofing will void the warranty.**

## 5.8 Energy Meter Connection

The single-phase energy meter should be installed next to the main switch.

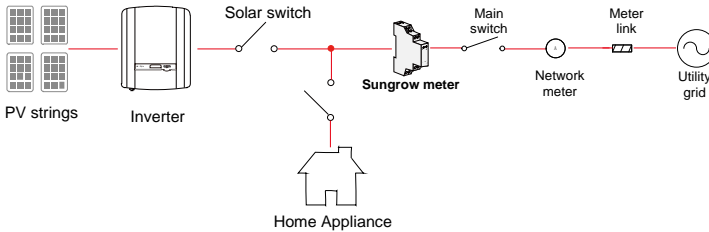

Proceed as follows to connect the RS485 wires to the inverter.

1. (Optional) If the RS485 cable is prepared by the customer, we recommend the shield twisted pair cable or shield Ethernet cable. Strip the insulation layer of the RS485 cable with an Ethernet wire stripper, and lead the corresponding RS485A/B signal cables out. Then insert the stripped communication cable into the RJ45 plug in the correct order, and crimp it with a crimper.

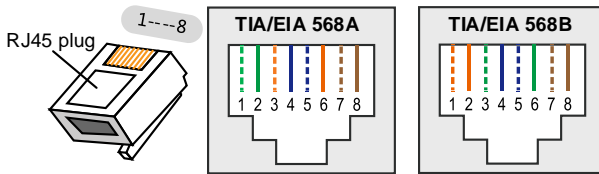

Tab. 5-2 Pin Definitions of the RJ45 Plug

RJ45 connector	Pin	Color	Description
TIA/EIA 568A	6	Orange	RS485- B
	8	Brown	RS485+ A
TIA/EIA 568B	6	Green	RS485- B
	8	Brown	RS485+ A



Pin 1 and pin 2 are configured to supply power for communication modules. Never connect or use these two pins when preparing the RS485 communication cable. Otherwise, damage can be caused to inverters or other devices connected through the communication cable.

- Loosen the screws and remove the waterproof lid from the **Meter|DRM** terminal.

Note:

Retain the screws for later installation.

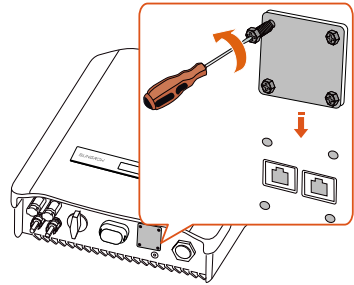

- Insert the RJ45 plug into the left (Meter) port until it makes a clicking sound.

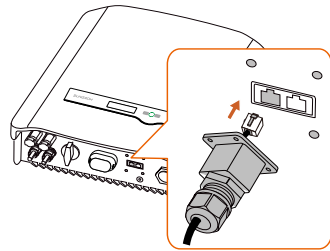

- If no external demand response enabling device connected, secure the waterproof lid to the inverter bottom with four screws (torque 1.5 N·m) and then fasten the swivel nut (torque 4 N·m to 5 N·m).

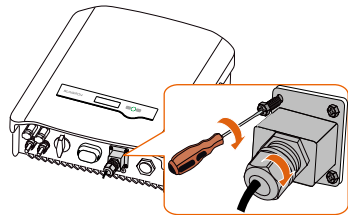

## 5.9 DRM Connection (“AU”/“NZ”)

The cable for connecting to the DRED is not included in the delivery.

Use a TIA/EIA 568B standard network cable with a diameter of 3 mm–5.3 mm.

1. Take out the communication connector from the packaging, as shown on the right.

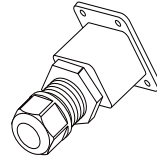

2. Loosen the screws and remove the waterproof lid from the **Meter|DRM** terminal.

Note:

Retain the screws for later installation.

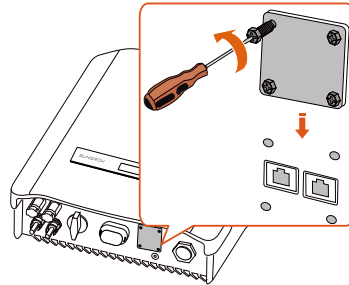

3. Unscrew the swivel nut from the cable gland and remove the waterproof plug from the right inlet. Lead the cable through the cable gland then the right inlet.

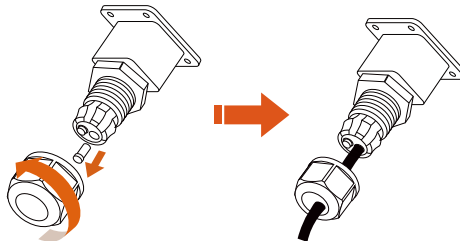

4. Use the Ethernet crimper to crimp the cable and carefully push all 8 unstripped colored wires into the RJ45 plug according to local standard, as shown below.

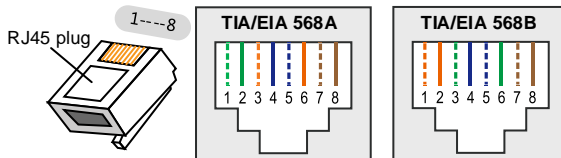

5. Insert the RJ45 plug into the right port (DRM) until it makes a clicking sound.
6. Secure the waterproof lid to the inverter bottom with four screws (torque 1.5 N·m) and then fasten the swivel nut (torque 4 N·m to 5 N·m).
7. Connect the other end to the external device.

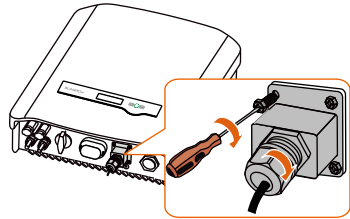
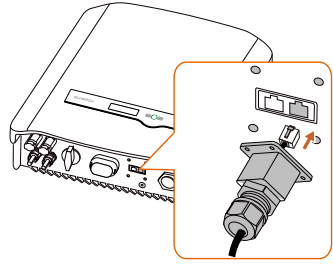

# 6 Commissioning

## 6.1 Inspection before Commissioning

Check the following items before starting the inverter:

1. The inverter DC switch and external circuit breaker are disconnected.
2. The inverter should be accessible for operation, maintenance and service.
3. Nothing is left on the top of the inverter.
4. The inverter is correctly connected to the external devices, and the cables are routed in a safe place or protected against mechanical damage.
5. The selection of the AC circuit breaker is in accordance to this manual and all applicable local standards.
6. All unused terminals at the bottom of the inverter are properly sealed.
7. Warning signs and labels are intact and legible.

## 6.2 Button Function

Inverter offers two buttons with multiple functions. Please refer to the following table before any operation of the inverter.

**Tab. 6-1** Button function

Button	Operation	Description
ESC	≤1.2 s	Navigate up / down or change the setting values. Hereinafter referred to as "Touch ESC".
	> 1.2 s	Return to a previous menu or cancel the settings. Hereinafter referred to as "Press ESC".
ENT	≤1.2 s	Move left or right, or turn pages, or view the active error/warning from the main screen. Hereinafter referred to as "Touch ENT".
	> 1.2 s	Enter the sub-menu or confirm a selection or settings. Hereinafter referred to as "Press ENT".

## 6.3 Commissioning Procedure

If all of the items mentioned above meet the requirements, proceed as follows to start up the inverter for the first time.

1. Rotate the DC switch of the inverter to "ON" position.
2. Connect the AC switch (if applicable) between the inverter and the grid.
3. Connect the DC switch (if applicable) between the inverter and the PV string.
4. If there is sufficient sunlight, the inverter will enter the running state and start to feed AC power to the grid. The LCD screen will be activated 5s later.

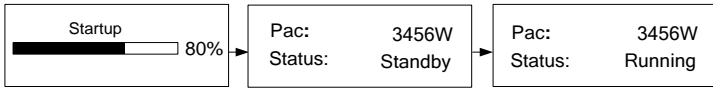

5. Observe the status of the indicator.

**Tab. 6-2** Indicator Status Description

Status	Description
Green	Steady on. The inverter is running normally, or with a warning, or with power limitation. Inverter status: Running, DRMx.
	Flash once every 1s. The inverter is in the status of standby, startup or Turn off (via LCD menu).
Red	Steady on. Inverter faults.
	Flash quickly every 0.2s. Grid faults.
	Flash slowly every 1s. PV faults.

Indicator lights of the communication module are described in the respective manual.

6. Visit [www.isolarcloud.com](http://www.isolarcloud.com) or iSolarCloud App to view inverter information. More detailed information on the indicator of the communication module can be found in the respective Quick Guide.

# 7 LCD Operation

## 7.1 Button Function

The inverter offers two buttons with multiple functions. Please refer to the following table before any operation of the inverter.

**Tab. 7-1** Button function

Button	Operation	Description
ESC	≤1.2 s	Navigate up / down or change the setting values. Hereinafter referred to as "Touch ESC".
	> 1.2 s	Return to a previous menu or cancel the settings. Hereinafter referred to as "Press ESC".
ENT	≤1.2 s	Move left or right, or turn pages, or view the active error/warning from the main screen. Hereinafter referred to as "Touch ENT".
	> 1.2 s	Enter the sub-menu or confirm a selection or settings. Hereinafter referred to as "Press ENT".

### CAUTION

**Risk of burns due to hot components!**

**Do not touch any hot parts (such as heat sink) during operation. Only the buttons and the DC switch can safely be touched at any time.**

## 7.2 Main Screen

After successful commissioning, the LCD screen will enter the main screen.

Pac:	3456W	— Inverter power
Status:	<b>Running</b>	— Inverter status

If there is no button operation for:

- 1 minute, LCD backlight will be automatically deactivated;
- 2 minutes, system will return to the default menu (main screen).



When there is no button operation for more than 8 seconds on the main screen, the displayed information will automatically cycle through to provide additional data: Main screen, energy, PV data, utility grid data. The screen will cycle every 2 seconds. Press any button to quit this mode.

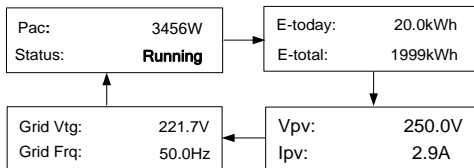

\* The images shown here are for your reference only. For –D series, all PV input information will be displayed.

**Tab. 7-2** Status Description

State	Description
Standby	The inverter waits for sufficient sunlight, then the DC voltage recovers.
Startup	The inverter is initializing and synchronizing with the grid.
Running	After being energized, the inverter tracks the PV strings' maximum power point (MPP) and feeds the AC power to grid. This mode is the normal mode.
DRMx	The inverter is connected to an external demand response enabling device and the DRM switch is set to ON via the LCD menu.
Turn off	The inverter will stop running by manual "OFF" via the LCD menu or with the DRM0 command from external DRED. Set to "ON" if you want to restart the inverter.
Upgrading	The DSP or LCD firmware is upgrading.
Error xxx	If an error occurs, the inverter will automatically stop operation, trigger the AC relay and show "Error xxx" on the LCD with the indicator red (xxx is the error code). Once the error is cleared in recovery time, the inverter will automatically try to resume normal operation. The recovery time can be set via the App.

**NOTICE**

**If the device is in standby mode for more than 10 minutes, please check:**

- **Whether the insolation is sufficient and the PV connection is correct.**
- **If no anomaly is found, disconnect and reconnect the DC switch and the main switch to restart.**
- **If it still does not work, contact SUNGROW.**

### Viewing the Active Error/Warning

If the status on the main screen is “Error xxx”, **Touch ENT** to view the active error code.  
 If the inverter is running with a warning, **Touch ENT** to view the active warning code.  
 Only one error or warning can be displayed on this screen. Refer to “9.1 Troubleshooting” for a solution.

Error	010
or	
Warning	514

## 7.3 Menu Structure

For the running information, the power value indicated represents the average value during the time interval.

The energy yields displayed are indicative only. For the actual yields, please refer to the energy meter of electric utility company.

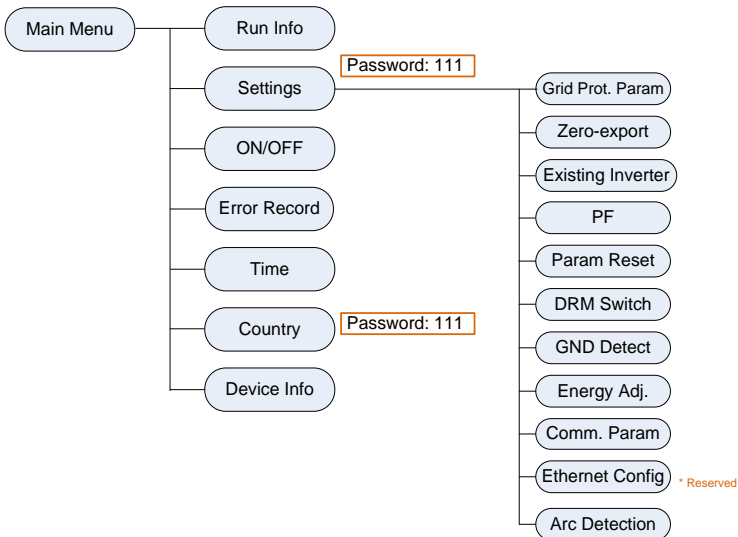

Fig. 7-1 LCD Menu Tree

## 7.4 Viewing Running Info

Proceed as follows to look through the detailed running information.

**Main Screen (Press ENT) → Menu → Run Info (Press ENT)**

Scroll pages by touching ENT / ESC.

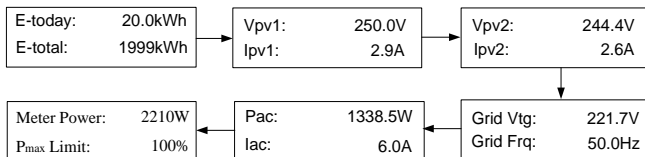

Meter power:

+ (omitted): The inverter is sourcing power to the grid.

-: The inverter is sinking power from the grid.

$P_{max}$  limit: only indicated for the derating in the event of over-temperature, overvoltage or over-frequency.

## 7.5 Advanced Settings

### 7.5.1 Inputting the Password

The parameter settings are protected with a password. If you want to set the inverter's parameters, you have to input the correct password.

**Main Screen (Press ENT) → Menu (Touch ESC) → Settings (Press ENT)**

**Touch ESC** to add the value and **Touch ENT** to move the cursor. Input the password **111**.

Password:    1 1 1
--------------------

**Press ENT** to confirm the password and enter the submenu.

**Touch ESC** to navigate down and **Press ENT** to confirm.

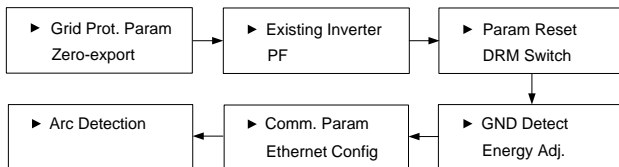

### 7.5.2 Setting Protective Parameters

Protective parameters are designed for the threshold values that can trigger the protective function of the inverter. The threshold values are compliant with the requirements of local safety standards and the utility grid.

If the protection function is triggered, the inverter will automatically disconnect from the grid with the "Error xxx" state displayed on the LCD main screen. After the grid voltage or frequency recovers to the specified range, the inverter will start running normally and can reconnect to the grid.

**Touch ESC** to choose the item and **press ENT** to enter the setting interface.

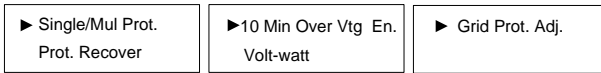

#### Single/Multiple Protection

**Touch ESC** to change the value and **touch ENT** to move the cursor.

Confirm settings by **pressing ENT**.

Confirm settings and scroll pages by **pressing ENT**.

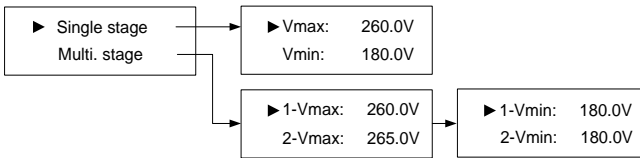

**Tab. 7-3** Protective Parameters and the Range

Parameter	Explanation	Range
$V_{max}$	Grid over-voltage	230.0 V–311.0 V
$V_{min}$	Grid under-voltage	23.0 V–230.0 V
1- $V_{max}$	Grid over-voltage 1 (V>)	230.0 V–311.0 V
2- $V_{max}$	Grid over-voltage 2 (V>>)	230.0 V–311.0 V
1- $V_{min}$	Grid under-voltage 1 (V<)	23.0 V–230.0 V
2- $V_{min}$	Grid under-voltage 2 (V<<)	23.0 V–230.0 V

\* Refer to **Tab. 7-9** for the default values of the parameters.

#### NOTICE

**Too high grid voltage may affect the normal usage and the life of household loads. The loss of any or all the warranty rights may follow if the protection set-point is beyond the specified range.**

### Protection Recover

**V<sub>max-rec</sub>** (230.0 V–311.0 V):

Recovery value for over-voltage error. Inverter will start operating when the grid voltage falls below this value.

**V<sub>min-rec</sub>** (23.0 V–230.0 V):

Recovery value for under-voltage error. Inverter will start operating when the grid voltage is above this value.

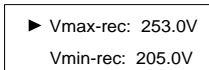

**Tab. 7-4** Default Parameters for Grid Standards in “AU”/“NZ”

Parameter	Other (Default)	AG	EE	EG	PN	PC	WP
V <sub>max-rec</sub> (V)	253.0	253.0	253.0	253.0	253.0	253.0	253.0
V <sub>min-rec</sub> (V)	205.0	205.0	182.0	182.0	205.0	205.0	205.0

**Tab. 7-5** Default Parameters for Grid Standards in “TH”

Parameter	220 V Grid	230 V Grid
V <sub>max-rec</sub> (V)	240.0	237.2
V <sub>min-rec</sub> (V)	200.0	202.0

### 10-Minute Over-voltage Protection (“AU”/“NZ”)

**ON:** enables the protection function by default. The inverter will automatically disconnect from the grid within 3 s when the average voltage for a 10 min period exceeds the set-point of *10 Min Over Vtg.*

**OFF:** disables the function.

Range: 244.0 V–258.0 V

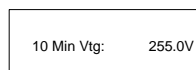

The default value of 10 Min Vtg is 248.0 V for New Zealand (code “NZ”). Refer to the following table for different grid standards in Australia.

Parameter	Other (Default)	AG	EE	EG	PN	PC	WP
10 Min Vtg	255.0	255.0	255.0	257.0	258.0	255.0	258.0

### Volt-watt Response (“AU”/“NZ”)

The Volt-watt response mode is enabled by default.

Set four grid voltage reference values. The output power of the inverter will vary in response to the grid voltages.



**Tab. 7-6** “Volt-watt” Mode Parameter Explanations

Parameter	Explanation	Default		Range
		AU	NZ	
V1 Ref.	Grid voltage reference value 1	207.0 V	207.0 V	Not applicable
V2 Ref.	Grid voltage reference value 2	220.0 V	220.0 V	216 V–230 V
V3 Ref.	Grid voltage reference value 3	250.0 V	244.0 V	235 V–255 V
V4 Ref.	Grid voltage reference value 4	265.0 V	255.0 V	244 V–265 V

The response curve is defined by the voltage reference values and corresponding power levels.

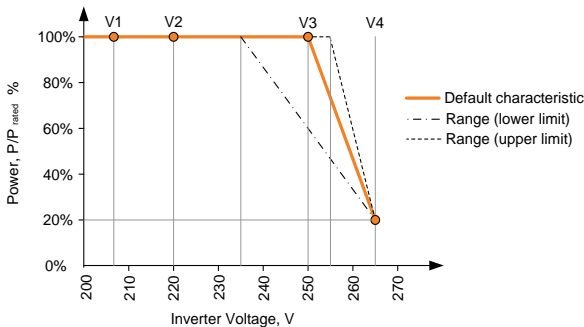

**Fig. 7-2** Volt-watt Response Curve (“AU” for example)

### Grid Protection Voltage Adjusting

All Sungrow’s inverters are compliant with the standard AS/NZS 4777 related to grid protection requirements. In order to work with unstable utility grids, inverters are equipped with automatic protection voltage adjusting function (disabled by default). This mode can be enabled via the LCD.

**OFF** (default setting): the function is disabled. The grid protection voltage cannot automatically adjust.

**ON**: enables the protection function. The inverter will automatically adjust the protection threshold to a higher value so as to be normally connected to the grid in the event of grid over-voltage. The  $V_{max-rec}$  will be adjusted the same with the  $V_{max}$ , with an upper limit value not higher than  $V_{max}$ .

If the setting is changed from **ON** to **OFF**, you should set the protection voltage as specified in **Tab. 7-3** according to local protection requirements.



**NOTICE**

**If the automatic protection voltage adjusting function is set to ON, the volt-watt response and the 10-minute over-voltage protection function will be automatically disabled.**

**If the line voltage or frequency goes outside pre-determined parameters, the inverter must shut down for safety purposes, which means it is not a faulty inverter in these instances. High line voltages may damage home appliances and Sungrow is not held responsible or liable for these issues.**

**7.5.3 Zero-export Setting**

**Touch ENT / ESC** to select and **press ENT** to confirm.

**Touch ESC** to change the value and **touch ENT** to move the cursor. **Press ENT** to confirm the export power percentage.

**OFF:** all the power will be exported to the grid. (by default)

**ON:** no power will be exported to the grid.

**Partial:** part of the export power will be exported to the grid.

**Total Export:** the export power upper limit of the whole system.

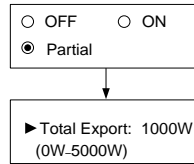

The range of export power will automatically change:

When the existing inverter is disabled: 0 to (rated power of the inverter)

When the existing inverter is enabled:

The lower limit is the rated power of existing inverter.

The upper limit is ([rated power of the existing inverter] + rated power of the inverter).

For example, retrofit an existing PV system (rated power: 2000 W) with SG5K-D (rated power: 5000 W). The total export range will be 2000 W – 7000 W.

A prompt will appear when you set it for the second time.

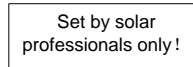

**NOTICE**

**With the password 111, the zero-export setting can only be done at the first time. The later modification can be performed by professionals only, please contact SUNGROW.**

### 7.5.4 Adding the Existing Inverter

**Rated-P:** rated power of the existing inverter.

This function is **OFF** by default. If the existing inverter is set to **ON**, its rated power is the lower limit for export power setting.

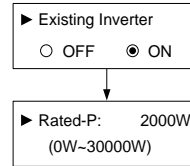

### 7.5.5 PF Setting

The inverter is capable of operating with fixed power factor. The PF ranges from 0.8 leading (+) to 0.8 lagging (-).

**+ (Leading):** the inverter is sourcing reactive power to the grid.

**- (Lagging):** the inverter is sinking reactive power from the grid.



### 7.5.6 Parameter Reset

#### NOTICE

**All settable parameters will return to the default values once the “Param Reset” operation is performed.**

**Press ENT** to confirm the operation.

**Press ESC** to discard the operation.

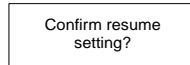

### 7.5.7 DRM Switch Setting (“AU”/“NZ”)

**Touch ENT / ESC** to select and **press ENT** to confirm.

**ON:** enable the DRM function.

**OFF:** disable the DRM function. (By default)

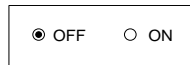



### 7.5.8 GND Detection

**Touch ENT / ESC** to select and **press ENT** to confirm.



Select **ON** to enable the GND Detection. If the enclosure of the inverter is not grounded, the error code 106 will be shown on the main screen. The buzzer inside will sound at the same time.

### 7.5.9 Energy Adjustment

If the accumulative value “E-total” displayed on inverter screen is different from the value indicated on the metering device, you should adjust the energy deviation.

(Energy Adj. value) = (Real measured value) - (E-total reading value)

**Touch ESC** to add the value and **Touch ENT** to move the cursor. **Press ENT** to confirm the setting.

The “+” can be changed to “-” by **touching ESC**.

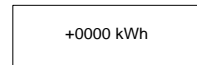

The adjustment ranges from -9999 kWh to +9999 kWh.

### 7.5.10 Setting Communication Parameter

**Touch ESC** to set the appropriate value and **touch ENT** to move the cursor. Confirm settings by **pressing ENT**.

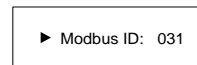

Device address range: 1-247.

### 7.5.11 Ethernet Configuration

The Ethernet setting is reserved for later usage.

**Touch ENT** to select and **press ENT** to confirm.

**OFF:** The IP address should be assigned manually.

**ON:** Automatically assign IP address from the home router.

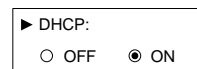

**Touch ESC** to switch between the DHCP and the IP interfaces.

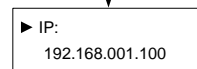

## 7.5.12 Arc Detection

**Touch ENT** to select and **press ENT** to confirm.

▶ Arc Self-test
Clear Arc Fault

## 7.6 Starting/Stopping the Inverter

**Main Screen (Press ENT) → Menu (Touch ESC) → ON/OFF (Press ENT)**

**Touch ENT / ESC** to select and **press ENT** to confirm.

<input type="radio"/> ON	<input checked="" type="radio"/> OFF
--------------------------	--------------------------------------

Confirm your selection by **pressing ENT**.

Confirm turn on?
------------------

Confirm turn off?
-------------------

## 7.7 Viewing the Error Record

**Main Screen (Press ENT) → Menu (Touch ESC) → Error Record (Press ENT)**

Scroll pages by **touching ENT / ESC**.

3 records can be displayed on each page and 20 records at most for all.

		P1/7
1	15/01/21 09:10:12	010
2	15/01/21 09:10:08	004
3	15/01/21 09:11:08	005

**Press ESC** to exit.

## 7.8 Setting the Time

The correct system time is very important. If there is deviation between the system time and the local time, the inverter will not operate normally. The clock is in 24-hour format.

**Main Screen (Press ENT) → Menu (Touch ESC) → Time (Press ENT)**

**DD**, **MM**, and **YY** stand for day, month, and year respectively.

	DD / MM / YY
Date:	05 / 01 / 17

**hh**, **mm**, and **ss** stand for hour, minute, and second respectively.

	hh : mm : ss
Time:	10 : 30 : 05

Scroll pages by **pressing ENT**.

## 7.9 Setting the Country

To make the protection parameters setting convenient, inverter provides built-in protection parameters for certain countries. The country setting is protected with a password.

**Main Screen (Press ENT) → Menu (Touch ESC) → Country (Press ENT)**

**Touch ESC** to add the value and **Touch ENT** to move the cursor. Input the password **111**.

Password:	1 1 1
-----------	-------

**Touch ENT / ESC** to choose the country and **press ENT** to confirm.

<input type="radio"/> GB	<input type="radio"/> DE	<input type="radio"/> FR	<input type="radio"/> IT	<input type="radio"/> ES
<input type="radio"/> AT	<input checked="" type="radio"/> AU	<input type="radio"/> CZ	<input type="radio"/> BE	<input type="radio"/> BRA
<input type="radio"/> CN	<input type="radio"/> SE	<input type="radio"/> TH	<input type="radio"/> KR	<input type="radio"/> LUX
<input type="radio"/> NZ	<input type="radio"/> NL	Other		

If the country selected is not in the list, please choose Other and then set the protection parameters manually.

**Tab. 7-7** Country Code Description

Code	Full Name	Language	Code	Full Name	Language
GB	Great Britain	English	BRA	Brazil	Portuguese
DE	Germany	German	CN	China	Chinese
FR	France	French	SE	Sweden	English
IT	Italy	Italian	TH	Thailand	English
ES	Spain	English	KR	Korea	English
AT	Austria	German	LUX	Luxemburg	German
AU	Australia	English	NZ	New Zealand	English
CZ	Czech	English	NL	Netherlands	English
BE	Belgium	English	Other	Country not included above	English

\* The country code "Other" represents 50 Hz grid and 60 Hz grid. The inverter will automatically choose 50 Hz or 60 Hz according to the local grid frequency.

If the country code is set to “AU”, the grid company setting will appear. **Touch ENT / ESC** to choose the grid standard and **press ENT** to confirm.

AG EE PN PC  
WP EG Other

When the grid is set to “EE” or “EG”, the reactive power regulation will be in PF mode with the power factor of +0.90 (lagging).

**Tab. 7-8** Grid Standard Description

Grid company Code	Company
AG	AusGrid, NSW
EE	Ergon Energy, QLD
PN	SA Power Networks, SA
PC	Powercor, VIC
WP	Western Power, WA
EG	Energex, QLD
Other	Company not mentioned above

Each grid standard code represents corresponding protective parameters that have been preset before delivery. The parameters for “Other” are applicable to Australian and compliant with the standard AS/NZS 4777.

The values listed in the following table are for your reference only. Please follow the requirements of local grid standard.

**Tab. 7-9** Protective Parameters of Grid Standards in “AU”

Parameter	Other (Default)	AG	EE	EG	PN	PC	WP
<b>Over-voltage</b>							
1- $V_{max}$ (V)	260.0	260.0	260.0	260.0	260.0	260.0	260.0
1-Time (s)	2.0	2.0	2.0	2.0	2.0	2.0	2.0
2- $V_{max}$ (V)	265.0	265.0	265.0	265.0	265.0	265.0	265.0
2-Time (s)	0.20	0.20	0.20	0.20	0.20	0.20	0.20
<b>Under-voltage</b>							
1- $V_{min}$ (V)	180.0	200.0	180.0	180.0	180.0	180.0	180.0
1-Time (s)	2.0	2.0	2.0	2.0	2.0	2.0	2.0
2- $V_{min}$ (V)	180.0	200.0	180.0	180.0	180.0	180.0	180.0
2-Time (s)	2.0	2.0	2.0	2.0	2.0	2.0	2.0
<b>Over-frequency</b>							
1- $F_{max}$ (Hz)	52.00	52.00	52.00	52.00	52.00	52.00	51.50
1-Time (s)	0.20	0.20	0.20	0.20	0.20	0.20	0.20
2- $F_{max}$ (Hz)	52.00	52.00	52.00	52.00	52.00	52.00	51.50
2-Time (s)	0.20	0.20	0.20	0.20	0.20	0.20	0.20
<b>Under-frequency</b>							
1- $F_{min}$ (Hz)	47.00	48.00	47.00	47.00	47.00	47.00	47.00
1-Time (s)	1.50	1.50	1.50	1.50	1.50	1.50	1.50
2- $F_{min}$ (Hz)	47.00	48.00	47.00	47.00	47.00	47.00	47.00
2-Time (s)	1.50	1.50	1.50	1.50	1.50	1.50	1.50

Parameter	Other (Default)	AG	EE	EG	PN	PC	WP
<b>10-min voltage</b>							
1-V <sub>10-min</sub> (V)	255.0	255.0	255.0	257.0	258.0	255.0	258.0



Refer to **Tab. 7-3** for the parameter explanation and range. If you (qualified personnel only) need to modify the voltage protective parameters, please refer to **“Single/Multiple Protection”**.

If the country code is set to “TH”, the grid type setting will appear. **Touch ENT / ESC** to choose the grid voltage and **press ENT** to confirm.

<input checked="" type="radio"/> 220V <input type="radio"/> 230V
---

**Tab. 7-10** Protective Parameters of Grid Standards in “TH”

Parameter	220 V Grid	230 V Grid	Parameter	220 V Grid	230 V Grid
<b>Over-voltage</b>			<b>Under-voltage</b>		
1-V <sub>max</sub> (V)	242.0	239.2	1-V <sub>min</sub> (V)	198.0	200.0
1-Time (s)	1.0	2.0	1-Time (s)	2.0	2.0
2-V <sub>max</sub> (V)	264.0	310.5	2-V <sub>min</sub> (V)	110.0	115.0
2-Time (s)	0.16	0.05	2-Time (s)	0.3	0.10
<b>Over-frequency</b>			<b>Under-frequency</b>		
1-F <sub>max</sub> (Hz)	52.00	52.00	1-F <sub>min</sub> (Hz)	47.00	47.00
1-Time (s)	0.10	0.10	1-Time (s)	0.10	0.10

## 7.10 Viewing Device Info

**Main Screen (Press ENT) → Menu (Touch ESC) → Device Info (Press ENT)**

These interfaces show the read-only information.

Scroll pages by **touching ENT / ESC**.

**Press ESC** to exit.

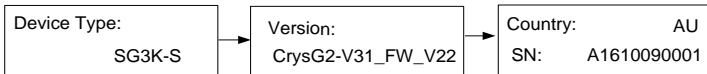

## 8 System Decommissioning

### 8.1 Disconnecting the Inverter

For maintenance or other service work, the inverter must be switched off.

Proceed as follows to disconnect the inverter from the AC and DC power sources. Lethal voltages or damage to the inverter will follow if otherwise.

1. Stop the inverter via the LCD menu. For details, see “7.6 Starting/Stopping the Inverter”.
2. Disconnect the AC circuit breaker and secure it against reconnection.
3. Rotate DC switch to “OFF” position and then disconnect all of the PV string inputs.
4. Wait at least 10 minutes until the capacitors inside the inverter completely discharge.
5. Ensure that the DC cable is current-free via a current clamp.
6. Insert a MC4 wrench into the notch and press the wrench with an appropriate force to remove the DC connector.

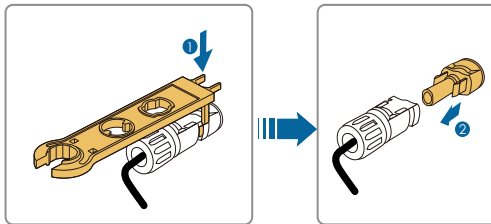

7. Lay the tool in the location of snap and press the tool down. Remove the AC connector, ensure that the AC wiring terminals are voltage-free via a multimeter, and remove the AC wires.
8. Install the MC4 waterproof plugs and AC waterproof cover.



For further disconnection and conductor reconnection instruction, please visit the webpage of respective component manufacturer.

## 8.2 Dismantling the Inverter

### CAUTION

**Risk of burn injuries and electric shock!**

**Do not touch any inner live parts for at least 10 minutes after disconnecting the inverter from the utility grid and the PV input.**

1. Refer to “**5 Electrical Connection**” for the inverter disconnection of all cables in reverse steps.
2. Dismantle the inverter referring to “**4 Mechanical Mounting**” in reverse steps.
3. If necessary, remove the wall-mounting bracket from the wall.
4. If the inverter will be reinstalled in the future, please refer to “**3.4 Inverter Storage**” for a proper conservation.

## 8.3 Disposing of the Inverter

Users take the responsibility for the disposal of the inverter.

### NOTICE

**Some parts and devices of the inverter, such as the capacitors, may cause environment pollution.**

**Do not dispose of the product together with household waste but in accordance with the disposal regulations for electronic waste applicable at the installation site.**

# 9 Troubleshooting and Maintenance

## 9.1 Troubleshooting

### 9.1.1 LED Indicator

See “**Tab. 6-2Indicator Status Description**” for the definition.

Fault Type	Troubleshooting
LED indicator cannot be lit.	<ol style="list-style-type: none"><li>1. Disconnect the AC circuit breaker.</li><li>2. Rotate the DC switch to “OFF”.</li><li>3. Check the polarity of DC input.</li></ol>
Green indicator goes out.	<ol style="list-style-type: none"><li>1. Disconnect the AC circuit breaker.</li><li>2. Rotate the DC switch to “OFF”.</li><li>3. Check the inverter electrical connection. Refer to “<b>5 Electrical Connection</b>”.</li><li>4. Check whether the voltage of DC input exceeds the inverter start-up voltage.</li><li>5. If all the above conditions are OK, please contact SUNGROW.</li></ol>

### 9.1.2 Errors on the App or LCD Screen

If an error occurs, the “Error” state will be shown on the main screen. We need the following information to provide you with the best assistance:

- inverter model (e.g. string, central, grid-connected, hybrid, transformerless, single phase, triple phase, single MPPT, multiple MPPTs),
- product name,
- serial number of the inverter,
- error code / name, and
- a brief description of the problem.



Code	Description	Troubleshooting
002	Grid over-voltage. The grid voltage exceeds the protective value. (stage I)	<ol style="list-style-type: none"> <li>1. Check the voltage of the grid.</li> <li>2. If the grid voltage exceeds the permissible range of inverter protection parameters, ask utility grid company for solution.</li> <li>3. If the grid voltage is within the permissible range, contact Sungrow Service Dept.</li> </ol>
003	Transient over-voltage. The grid transient voltage exceeds inverter allowable upper limit.	<ol style="list-style-type: none"> <li>1. This is a short-term fault due to grid condition. Wait a moment for inverter recovery.</li> <li>2. If the fault persists, please contact Sungrow Service Dept.</li> </ol>
004	Grid under-voltage. The grid voltage is below the protective value. (stage I)	<ol style="list-style-type: none"> <li>1. Check the grid voltage.</li> <li>2. If the grid voltage exceeds the permissible range of inverter protection parameters, ask utility grid company for solution.</li> <li>3. If the grid voltage is within the permissible range, contact Sungrow Service Dept.</li> </ol>
005	Grid under-voltage. The grid voltage is below the protective value, which is lower than the protective value of error 004.(stage II)	<ol style="list-style-type: none"> <li>1. This is a short-term fault due to grid condition. Wait a moment for inverter recovery.</li> <li>2. If the fault persists, please contact Sungrow Service Dept.</li> </ol>
006	AC over-current. The AC output current exceeds inverter allowable upper limit.	<ol style="list-style-type: none"> <li>1. The inverter will resume if the output current falls below the protection value.</li> <li>2. If the fault persists, please contact Sungrow Service Dept.</li> </ol>
007	Transient overcurrent. AC	<ol style="list-style-type: none"> <li>1. The inverter will self-recover after several seconds.</li> <li>2. If the fault persists, please contact Sungrow Service Dept.</li> </ol>
008	Grid over-frequency. The grid frequency exceeds the protective value. (stage I)	<ol style="list-style-type: none"> <li>1. Check the grid frequency.</li> <li>2. If the grid frequency exceeds the permissible range of inverter protection parameters, ask utility grid company for solution.</li> </ol>
009	Grid under-frequency. The grid frequency is below the protective value. (stage I)	<ol style="list-style-type: none"> <li>3. If the grid frequency is within the permissible range, contact Sungrow Service Dept.</li> </ol>

Code	Description	Troubleshooting
010	Grid failure (Islanding)	<ol style="list-style-type: none"> <li>1. Check whether AC circuit breaker is triggered.</li> <li>2. Check whether AC cables are all firmly connected.</li> <li>3. Check whether grid is not in service.</li> <li>4. If all conditions are OK and this fault still occurs in the LCD screen, contact Sungrow Service Dept.</li> </ol>
011	DC injection over-current. The DC current injection of AC current exceeds the upper limit.	<ol style="list-style-type: none"> <li>1. Wait a moment for inverter recovery.</li> <li>2. If the fault occurs repeatedly, contact Sungrow Service Dept.</li> </ol>
012	Leakage current over-current. The leakage current exceeds inverter allowable upper limit.	<ol style="list-style-type: none"> <li>1. Check the PV strings for ground fault.</li> <li>2. If the fault occurs repeatedly, contact Sungrow Service Dept.</li> </ol>
014	10-minute grid over-voltage. The average grid voltage in 10 minutes exceeds the permissible range.	<ol style="list-style-type: none"> <li>1. Check whether the inverter selected country code is the country you are in.</li> <li>2. Wait a moment for inverter recovery.</li> <li>3. Check the voltage of the grid. If the grid voltage exceeds the permissible range of inverter protection parameters, ask utility grid company for solution.</li> <li>4. If the fault occurs repeatedly, contact Sungrow Service Dept.</li> </ol>
015	Grid over-voltage The grid voltage exceeds the protective value, which is higher than the protective value of error 002. (stage II)	<ol style="list-style-type: none"> <li>1. Check the model of the AC cables.</li> <li>2. Wait a moment for inverter recovery.</li> <li>3. If the grid voltage exceeds the permissible range, ask utility grid company for solution.</li> <li>4. If the fault occurs repeatedly, contact Sungrow Service Dept.</li> </ol>
016	The bus voltage or power is high.	<ol style="list-style-type: none"> <li>1. Wait a moment for inverter recovery.</li> <li>2. If the fault occurs repeatedly, contact Sungrow Service Dept.</li> </ol>
019	Bus transient over-voltage. The transient bus voltage exceeds inverter allowable upper limit.	<ol style="list-style-type: none"> <li>1. Wait a moment for inverter recovery.</li> <li>2. If the fault occurs repeatedly, contact Sungrow Service Dept.</li> </ol>
020	Bus over-voltage. The bus voltage exceeds inverter allowable upper limit.	<ol style="list-style-type: none"> <li>1. Wait a moment for inverter recovery.</li> <li>2. If the fault occurs repeatedly, contact Sungrow Service Dept.</li> </ol>
021	PV1 input over-current.	Check the layout and the wiring of PV1 input.

Code	Description	Troubleshooting
022	PV2 input over-current.	Check the layout and the wiring of PV2 input.
028	PV1 reverse connection.	Check the cable connections of PV1.
029	PV2 reverse connection.	Check the cable connections of PV2.
036	The temperature of radiator is too high.	<ol style="list-style-type: none"> <li>1. Check whether the ambient temperature shown on the screen is too high. Wait a moment for inverter recovery.</li> <li>2. Check whether there is enough space for convection.</li> <li>3. Check whether the inverter is in direct sunlight.</li> <li>4. Check whether the fan is normal. Replace it if necessary.</li> <li>5. Clean the air inlets.</li> <li>6. If the fault persists, please contact Sungrow.</li> </ol>
037	The internal temperature of inverter is too high.	<ol style="list-style-type: none"> <li>1. Wait a moment for inverter recovery.</li> <li>2. If the fault occurs repeatedly, contact Sungrow Service Dept.</li> </ol>
038	Relay fault on the grid side.	<ol style="list-style-type: none"> <li>1. Check whether there is a reliable inverter grounding line.</li> <li>2. Check whether one of the PV strings is short-circuited with ground.</li> <li>3. Wait a moment for inverter recovery.</li> <li>4. If the fault occurs repeatedly, contact Sungrow Service Dept.</li> </ol>
039	The insulation resistance of PV to earth is low. (ISO-ftt)	<ol style="list-style-type: none"> <li>1. Wait a moment for inverter recovery.</li> <li>2. If the fault occurs repeatedly, contact Sungrow Service Dept.</li> </ol>
041	Leakage current sampling fault.	<ol style="list-style-type: none"> <li>1. Wait a moment for inverter recovery.</li> <li>2. If the fault occurs repeatedly, contact Sungrow Service Dept.</li> </ol>
043	Inner under-temperature fault. The ambient temperature inside the inverter is too low.	The inverter will recover once the ambient temperature rises above -25°C.
044	Inverter self-test fault.	
045	PV1 boost circuit fault.	<ol style="list-style-type: none"> <li>1. Wait a moment for inverter recovery.</li> <li>2. If the fault occurs repeatedly, contact Sungrow Service Dept.</li> </ol>
046	PV2 boost circuit fault.	
048	Phase current sampling fault.	<ol style="list-style-type: none"> <li>1. Check the grid voltage.</li> <li>2. If the grid voltage exceeds the permissible range of inverter protection parameters, ask utility grid company for solution.</li> <li>3. If the grid voltage is within the permissible range, contact Sungrow Service Dept.</li> </ol>
053	The slave DSP detects that the grid voltage exceeds inverter allowable upper limit.	<ol style="list-style-type: none"> <li>1. Check the grid voltage.</li> <li>2. If the grid voltage exceeds the permissible range of inverter protection parameters, ask utility grid company for solution.</li> <li>3. If the grid voltage is within the permissible range, contact Sungrow Service Dept.</li> </ol>

Code	Description	Troubleshooting
054	The slave DSP detects that the grid frequency exceeds inverter allowable upper limit.	<ol style="list-style-type: none"> <li>1. Check the grid frequency.</li> <li>2. If the grid frequency exceeds the permissible range of inverter protection parameters, ask utility grid company for solution.</li> <li>3. If the grid frequency is within the permissible range, contact Sungrow Service Dept.</li> </ol>
056	The slave DSP detects that the leakage current exceeds inverter allowable upper limit.	<ol style="list-style-type: none"> <li>1. Check whether there is a grounded fault of the PV string.</li> <li>2. If the error occurs repeatedly, contact Sungrow Service Dept.</li> </ol>
059	Communication alarm between master DSP and slave DSP.	<ol style="list-style-type: none"> <li>1. Wait 1 minute for inverter recovery.</li> <li>2. If the fault persists, contact Sungrow Service Dept.</li> </ol>
061	Alarm for no inverter type setting.	Contact Sungrow Service Dept.
070	Fans are defective	Stop the inverter and disconnect the AC & DC cables. Check whether the fan duct has been blocked. If not, replace fans.
084	Warning for reverse cable connection of the Sungrow Meter.	<ol style="list-style-type: none"> <li>1. Check whether the power cable connections are correct.</li> <li>2. If "Existing Inverter" is set to "ON" via LCD menu, check and ensure that its rated power is correctly set.</li> <li>3. For Sungrow single-phase meter, check whether the CT clamp of the 1-phase sensor is correctly placed.</li> </ol>
085	Mismatched software version.	Please contact Sungrow Service Dept.
087	Arc detection module abnormal alarm.	Please contact Sungrow Service Dept.
088	Arc fault on PV side.	<ol style="list-style-type: none"> <li>1. Rotate the DC switch to "OFF" and check whether there are damaged cables, loose terminals or fuses, or poor contact. Replace it if necessary.</li> <li>2. Rotate the DC switch to "ON" and clear the error via the App or LCD menu.</li> <li>3. If the error occurs repeatedly, contact Sungrow Service Dept.</li> </ol>
089	The arc detection function is disabled.	<ol style="list-style-type: none"> <li>1. Enable the arc detection function via the App or LCD menu.</li> <li>2. If the error occurs repeatedly, contact Sungrow Service Dept.</li> </ol>
100	The AC output current exceeds the upper limit.	<ol style="list-style-type: none"> <li>1. The inverter will resume if the output current falls below the protection value.</li> <li>2. If the fault persists, please contact Sungrow Service Dept.</li> </ol>

Code	Description	Troubleshooting
101	Grid over-frequency. The grid frequency exceeds the protective value, which is higher than the protective value of error 008. (stage II)	1. Check the grid frequency. 2. If the grid frequency exceeds the permissible range of inverter protection parameters, ask utility grid company for solution.
102	Grid under-frequency. The grid frequency is below the protective value, which is lower than the protective value of error 009. (stage II)	3. If the grid frequency is within the permissible range, contact Sungrow Service Dept.
106	Abnormal grounding. Neither the PE terminal on the AC connection block nor the second PE terminal on the enclosure is reliably connected.	Check whether there is a reliable inverter grounding line, if there is access to the ground, and the fault persists, please contact Sungrow Service Dept.
200	Bus hardware over-voltage fault. The bus voltage exceeds the protective value.	1. Wait for inverter recovery after bus voltage lower. 2. If the fault occurs repeatedly, contact Sungrow Service Dept.
201	The bus voltage is too low.	1. Wait a moment for inverter recovery. 2. If the fault occurs repeatedly, contact Sungrow Service Dept.
202	PV hardware over-current fault. The PV1 or PV2 current exceeds the protective value.	If the fault occurs repeatedly, contact Sungrow Service Dept.
203	The PV input voltage exceeds the bus voltage.	Check the functionality of the PV connection terminals.
306	Input and output power mismatching fault.	If the fault occurs repeatedly, contact Sungrow Service Dept.
315	PV1 current sampling fault.	Channel sampling anomaly. Contact Sungrow Service Dept.
316	PV2 current sampling fault.	Contact Sungrow Service Dept.
320	Leakage current sensor fault.	Contact Sungrow Service Dept.
409	All temperature sensors fail.	
503	Ambient temperature sensor open circuit warning.	If the fault occurs repeatedly, contact Sungrow Service Dept.

Code	Description	Troubleshooting
504	Ambient temperature sensor short circuit warning.	
505	Radiator temperature sensor open circuit warning.	
506	Radiator temperature sensor short circuit warning.	
501	External memory reading/writing warning.	<ol style="list-style-type: none"> <li>1. Inverter can normally be connected to the grid.</li> <li>2. Power on the inverter again. If the fault persists, contact Sungrow Service Dept.</li> </ol>
514	Abnormal communication warning of the Sungrow Meter. (Inverter can be normally connected to the grid.)	<ol style="list-style-type: none"> <li>1. Check whether the power cable connections of the meter are correct.</li> <li>2. Check whether the RS485connection is correct.</li> </ol>

## 9.2 Maintenance

### DANGER

**Risk of inverter damage or personal injury due to incorrect service!**  
**Always keep in mind that the inverter is powered by dual sources: PV strings and utility grid.**  
**Before any service work, observe the following procedure.**

- Disconnect the AC circuit breaker and then set the DC load-break switch if the inverter to OFF;
- Wait at least 10 minutes for inner capacitors to discharge completely;
- Verify that there is no voltage or current before pulling any connector.

### DANGER

**Danger to life from electric shock due to live voltage**

- Do not open the enclosure when the inverter is working. Unauthorized opening will void guarantee and warranty claims and in most cases terminate the operating license.
- When the enclosure lid is removed, live components can be touched which can result in death or serious injury due to electric shock.

**⚠ CAUTION**

**Keep non-related persons away!**

**A temporary warning sign or barrier must be posted to keep non-related persons away while performing electrical connection and service work.**

**NOTICE**

**Restart the inverter only after removing the fault that impairs safety performance.**

**As the inverter contains no component parts that can be maintained, never arbitrarily replace any internal components.**

**For any maintenance need, please contact SUNGROW. Otherwise, SUNGROW shall not be held liable for any damage caused.**



Servicing of the device in accordance with the manual should never be undertaken in the absence of proper tools, test equipments or the latest revision of the manual which has been clearly and thoroughly understood.

Items	Methods	Period
System clean	Check the temperature and dust of the inverter. Clean the inverter enclosure if necessary. Check if the air inlet and outlet are normal. Clean the air inlet and outlet if necessary.	Six months to a year (it depends on the dust contents in air.)

# 10 Appendix

## 10.1 Technical Data

### 10.1.1 –S Series

Parameters	SG2K-S	SG2K5-S	SG3K-S
<b>Input Data</b>			
Max. PV input power	3000 W	3200 W	4000 W
Max. PV input voltage	600 V		
Startup voltage	120 V		
Nominal input voltage	360 V		
MPP voltage range	90 V–560 V		
MPP voltage range for nominal power	210 V–480 V	260 V–480 V	310 V–480 V
No. of MPPTs	1		
Max. number of PV strings per MPPT	1		
Max. PV input current	12.5A		
Max. PV short-circuit current	15 A		
Max. inverter backfeed current to PV string	0 A		
<b>Output Data</b>			
Nominal AC output power	2000 W	2500 W	3000 W
Max. AC output apparent power	2000 VA	2500 VA	3000 VA
Max. AC output current	9.1 A	11.3 A	13.7 A
Max. inrush current (peak value / duration)	8 A / 12 ms		
Max. output fault current (peak value / duration)	80 A / 3.2 ms		
Max. output over-current protection	25 A		
Nominal AC voltage	230 Vac(single phase)		
AC voltage range	180 Vac–276 Vac (this may vary with grid standards)		
Nominal grid frequency	50 Hz / 60 Hz		
Grid frequency range	45 Hz–55 Hz / 55 Hz–65 Hz (this may vary with grid standards)		
Total harmonic distortion (THD)	< 3 % (of nominal power)		
DC current injection	< 0.5 % (of nominal current)		



Parameters	SG2K-S	SG2K5-S	SG3K-S
Power factor	> 0.99 at default value at nominal power (adj. 0.8 leading to 0.8 lagging)		
<b>Protection</b>			
PV reverse connection protection	Yes		
AC short circuit protection	Yes		
Leakage current protection	Yes		
Anti-islanding protection	Yes (frequency shift)		
Grid monitoring	Yes		
PV string current monitoring	Yes		
DC switch	Yes (meet AS60947.3:2018)		
AFCI	Yes		
Overvoltage category	III [AC], II [DC]		
Surge protection	DC Type II / AC Type II		
Safety protection class	I		
<b>System Data</b>			
Max. efficiency	98.2 %	98.2 %	98.2 %
Max. European efficiency	97.2 %	97.5 %	97.7 %
Isolation method	Transformerless		
Ingress protection rating	IP65		
Power loss in night mode	< 3 W		
Pollution degree outside the enclosure	3		
Pollution degree inside the enclosure	2		
Operating ambient temperature	-25°C to +60°C		
Allowable relative humidity	0–100 % (non-condensing)		
Cooling method	Natural cooling		
Max. operating altitude	4000 m (derating when > 2000 m)		
Display	Graphic LCD		
Communication	Wi-Fi		
PV connection type	MC4 (Max. 6mm <sup>2</sup> )		
AC connection type	Plug and play connector (Max. 6mm <sup>2</sup> )		
<b>Mechanical Data</b>			
Dimensions (W x H x D)	300 mm x 370 mm x 125 mm		
Mounting method	Wall-mounting bracket		
Weight	8.5 kg		

### 10.1.2 –D Series

Parameters	SG3K-D	SG5K-D	SG8K-D
<b>Input Data</b>			
Max. PV input power	4000 W	6500 W	10400 W

Parameters	SG3K-D	SG5K-D	SG8K-D
Max. PV input voltage	600 V		
Startup voltage	120 V		
Nominal input voltage	360 V		
MPP voltage range	90 V–560 V	90 V–560 V	90 V–540 V
MPP voltage range for nominal power	160 V–480 V	260 V–480 V	275 V–480 V
No. of MPPTs	2		
Max. number of PV strings per MPPT	1/1	1/1	1 / 2
Max. PV input current	25 A (12.5 A/12.5 A)	25 A (12.5 A/12.5 A)	12.5 A / 25 A
Max. PV short-circuit current	30 A (15 A/15 A)	30 A (15 A/15 A)	15 A / 30 A
Max. inverter backfeed current to PV string	0 A		
<b>Output Data</b>			
Nominal AC output power	3000 W	4999 W	8000 W
Max. AC output apparent power	3000 VA	4999 VA	8000 VA
Max. AC output current	13.7 A	21.7 A	34.8 A
Max. inrush current (peak value / duration)	10A / 12 ms	10A / 12 ms	25 A / 12 ms
Max. output fault current (peak value / duration)	100 A / 3.2 ms	100 A / 3.2 ms	93 A / 3.2 ms
Max. output over-current protection	25 A	32 A	40 A
Nominal AC voltage	230 Vac (single phase)		
AC voltage range	180 Vac–276 Vac (this may vary with grid standards)		
Nominal grid frequency	50 Hz / 60 Hz		
Grid frequency range	45 Hz–55 Hz / 55 Hz–65 Hz (this may vary with grid standards)		
Total harmonic distortion (THD)	< 3 % (of nominal power)		
DC current injection	< 0.5 % (of nominal current)		
Power factor	> 0.99 at default value at nominal power (adj. 0.8 leading to 0.8 lagging)		
<b>Protection</b>			
PV reverse connection protection	Yes		
AC short circuit protection	Yes		
Leakage current protection	Yes		
Low voltage fault ride	No	No	Yes

Parameters	SG3K-D	SG5K-D	SG8K-D
through (LVFRT)			
Anti-islanding protection	Yes (frequency shift)		
Grid monitoring	Yes		
PV string current monitoring	Yes		
DC switch	Yes (meet AS60947.3:2018)		
AFCI	Yes		
Overvoltage category	III [AC], II [DC]		
Surge protection	DC Type II / AC Type II		
Safety protection class	I		
<b>System Data</b>			
Max. efficiency	98.4 %	98.4 %	98.5 %
Max. European efficiency	97.7 %	98.0 %	98.0 %
Isolation method	Transformerless		
Ingress protection rating	IP65		
Power loss in night mode	< 3 W		
Pollution degree outside the enclosure	3		
Pollution degree inside the enclosure	2		
Operating ambient temperature	-25°C to +60°C		
Allowable relative humidity	0–100 % (non-condensing)		
Cooling method	Natural cooling		
Max. operating Altitude	4000 m (derating when > 2000 m)		
Display	Graphic LCD		
Communication	Wi-Fi		
PV connection type	MC4 (Max. 6mm <sup>2</sup> )		
AC connection type	Plug and play connector (Max. 6mm <sup>2</sup> )		
<b>Mechanical Data</b>			
Dimensions (W x H x D)	360 mm x 390 mm x 133 mm		360 mm x 390 mm x 148 mm
Mounting method	Wall-mounting bracket		
Weight	11.5 kg		15.5 kg

## 10.2 Quality Assurance

When product faults occur during the warranty period, SUNGROW will provide free service or replace the product with a new one.

## Evidence

During the warranty period, the customer shall provide the product purchase invoice and date. In addition, the trademark on the product shall be undamaged and legible. Otherwise, SUNGROW has the right to refuse to honor the quality guarantee.

## Conditions

- After replacement, unqualified products shall be processed by SUNGROW.
- The customer shall give SUNGROW a reasonable period to repair the faulty device.

## Exclusion of Liability

In the following circumstances, SUNGROW has the right to refuse to honor the quality guarantee:

- If the free warranty period for the whole machine/components have expired.
- If the device is damaged during transport.
- If the device was incorrectly installed, refitted, or used.
- If the device is operated in a very improper environment, as described in this manual.
- If the fault or damage was caused by installation, repairs, modification, or disassembly performed by a service provider or personnel other than this company.
- If the fault or damage was caused by the use of non-standard or non-SUNGROW components or software.
- If the installation and use range are beyond stipulations of relevant international standards.
- If the damage was caused by an abnormal natural environment.

For faulty products in any of above cases, if the customer requests maintenance, paid maintenance service may be provided based on the judgment of SUNGROW.

## Contact Information

Should you have any question about this product, please contact us.

We need the following information to provide you the best assistance:

- Model of the inverter

- Serial number of the inverter
- Error code/name
- Brief description of the problem

**China (HQ)**

Sungrow Power Supply Co., Ltd  
 Hefei  
 +86 551 65327834  
[service@sungrowpower.com](mailto:service@sungrowpower.com)

**Australia**

Sungrow Australia Group Pty.  
 Ltd.  
 Sydney  
 +61 2 9922 1522  
[service@sungrowpower.com.au](mailto:service@sungrowpower.com.au)

**Brazil**

Sungrow Do Brasil  
 Sao Paulo  
 +55 11 2366 1957  
[latam.service@sa.sungrowpower.com](mailto:latam.service@sa.sungrowpower.com)

**France**

Sungrow France  
 Lyon  
 +33420102107  
[service@sungrow-emea.com](mailto:service@sungrow-emea.com)

**Germany, Austria, Switzerland**

Sungrow Deutschland GmbH  
 Munich  
 +49 0800 4327 9289  
[service@sungrow-emea.com](mailto:service@sungrow-emea.com)

**Greece**

Service Partner – Survey Digital  
 +30 2106044212  
[service@sungrow-emea.com](mailto:service@sungrow-emea.com)

**India**

Sungrow (India) Private Limited  
 Gurgaon  
 +91 080 41201350  
[service@in.sungrowpower.com](mailto:service@in.sungrowpower.com)

**Italy**

Sungrow Italy  
 Verona  
 +39 0800 974739 (Residential)  
 +39 045 4752117 (others)  
[service@sungrow-emea.com](mailto:service@sungrow-emea.com)

**Japan**

Sungrow Japan K.K.

Tokyo

+81 3 6262 9917

[service@jp.sungrowpower.com](mailto:service@jp.sungrowpower.com)**Korea**

Sungrow Power Korea Limited

Seoul

+82 70 7719 1889

[service@kr.sungrowpower.com](mailto:service@kr.sungrowpower.com)**Malaysia**

Sungrow SEA

Selangor Darul Ehsan

+60 19 897 3360

[service@my.sungrowpower.com](mailto:service@my.sungrowpower.com)**Philippines**

Sungrow Power Supply Co., Ltd

Mandaluyong City

+63 9173022769

[service@ph.sungrowpower.com](mailto:service@ph.sungrowpower.com)**Thailand**

Sungrow Thailand Co., Ltd.

Bangkok

+66 891246053

[service@th.sungrowpower.com](mailto:service@th.sungrowpower.com)**Spain**

Sungrow Ibérica S.A.U.

Mutilva

+34 948 05 22 04

[service@sungrow-emea.com](mailto:service@sungrow-emea.com)**Romania**

Service Partner - Elerex

+40 241762250

[service@sungrow-emea.com](mailto:service@sungrow-emea.com)**Turkey**Sungrow Deutschland GmbH  
Turkey

Istanbul

+90 216 663 61 80

[service@sungrow-emea.com](mailto:service@sungrow-emea.com)**UK**

Sungrow Power UK Ltd.

Milton Keynes

+44 (0) 01908 414127

[service@sungrow-emea.com](mailto:service@sungrow-emea.com)**U.S.A, Mexico**

Sungrow USA Corporation

Phoenix

+1 833 747 6937

[techsupport@sungrow-na.com](mailto:techsupport@sungrow-na.com)

**Vietnam**

Sungrow Vietnam

Hanoi

+84 918 402 140

[service@vn.sungrowpower.com](mailto:service@vn.sungrowpower.com)

**Belgium, Netherlands and  
Luxembourg (Benelus)**

+31 08000227012 (only for  
Netherlands)

[service@sungrow-emea.com](mailto:service@sungrow-emea.com)

---

**Poland**

-

+48 221530484

[service@sungrow-emea.com](mailto:service@sungrow-emea.com)

---